

www.janitza.com

Power Quality Analyser UMG 511

Installation and
commissioning

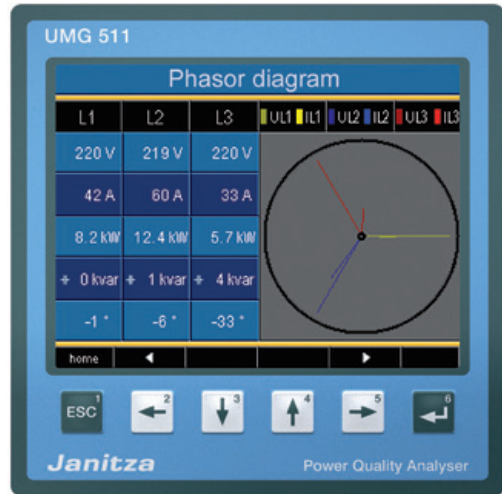

Janitza electronics GmbH
Vor dem Polstück 1
D-35633 Lahnau
Support Tel. 0049 6441 9642-22
Fax 0049 6441 9642-30
e-mail: info@janitza.com
Internet: <http://www.janitza.com>

Janitza®

Index of Contents		Configuration	48
General	3	Language	49
Goods-in check	6	Communication	50
Description	8	Measurement	52
Intended use	8	Transients	56
Features of UMG511	9	Events	58
Measurement process	10	Voltage mode	60
Operating concept	10	Nominal frequency	61
Programming software „GridVis“	11	Flicker	62
Assembly	12	System	63
Installation	14	Password	64
Protective Wire Connection	14	Delete power meters	65
Supply Voltage	14	Delete min. and max. values	66
Voltage measurement	16	Delivered condition	67
Frequency measurement	25	Reset	67
Current measurement	26	Display	68
Current direction	27	Extensions	71
RS485	30	Initialization	74
Ethernet	34	Applying the supply voltage	74
Digital outputs	36	Apply the measurement voltage	74
Digital inputs	38	Frequency measurement	75
Operation	40	Rotary field direction	75
Measurement value displays	41	Apply measurement current	76
„Home“ measurement value display	42	Checking the power measurement	78
Select measurement value display	43	Checking communication	78
Call up additional information	44	Profibus	80
Delete min/max values individually	45	Service and Maintenance	84
List of transients	46	Technical data	87
List of events	47		

General

Copyright

This handbook is subject to the legal regulations for copyright protection and may not be fully, or partially, photocopied, reprinted or reproduced, mechanically or electronically or in any other way, without the legally binding signature of

Janitza electronics GmbH, Vor dem Polstück 1,
D 35633 Lahnau, Germany
and may not be copied or republished in any way.

Protected trademarks

All trademarks, and the resulting rights, belong to the respective owner of these rights.

Disclaimer

Janitza electronics GmbH does not accept any responsibility for errors or mistakes within this handbook and is not obliged to keep the contents of this handbook updated.

Comments on the handbook

We are pleased to receive your comments. If there are any parts of this handbook that are not clear, please let us know and send an e-mail to:
info@janitza.de

Explanation of symbols

The following pictogrammes are used in this handbook.



Danger - voltage!

Danger of death or major injury. Disconnect the system and device before beginning any work.



Earth terminal.



Caution!

Please observe the documentation. This symbol warns about possible dangers that can occur during assembly, commissioning and use.



Inductive.

The current lags the voltage.



Capacitive.

The voltage lags the current.



Note.

Application Information

Please read this operating manual and all other publications that have to be consulted to work with this product (particularly for installation, operation or maintenance).

Please pay attention to all safety regulations and warning information. If you fail to follow the information, it can result in personal damage and/or damages to the product.

Any unauthorized change or use of this device beyond the specified mechanical, electrical or other operating limits can cause personal damage and/or damage to the product.

Any such unauthorized change represents „misuse“ and/or „negligence“ in the sense of guarantee for the product and therefore makes the guarantee covering possible consequential damages void.

This device is to be exclusively operated and maintained by a specialist.

Specialists are persons who, due to their relevant training and experience, are capable of recognizing risks and avoiding possible hazards that can be caused when operating or servicing the device.

When using the device, the necessary legal and safety regulations should be considered additionally for the respective application case.



Caution!

If the device is not operated according to the operating manual, protection is no longer ensured and the device may cause dangers.



Cables with single wires must be provided with ferrules.



Only screw plugs with the same pole number and the same type of construction can be plugged together.

Goods-in check

The correct and safe operation of this device requires appropriate transport, correct storage, positioning and assembly as well as careful operation and maintenance. If it can be assumed that risk-free operation is no longer possible, the device should be immediately taken out of operation and secured against being unintentionally being reinitialised.

Unpacking and packing should only be undertaken with the usual care with the application of force, while using suitable tools. The correct mechanical condition of the devices should be checked with visual tests. Please pay attention to the installation instructions included with the device.

It can be assumed that risk-free operation is no longer possible if, for example, the device:

- displays visible damages,
- does not work despite being connected to the mains,
- has been subject to unfavourable conditions (e.g. storage outside of the authorised climate limits without adaptation to the climate, thawing etc.) or transport stresses (e.g. fall from a height - even if there are no visible external damages).

Please check the completeness of the delivery before beginning with installation of the device.



All of the screw clamps belonging to the supplied device are already attached.



The installation and commissioning instructions also describe options that are not part of the scope of supply.



All supplied options and versions are described on the delivery note.

Scope of supply

Number	Art.no.	Designation
1	52 19 xxx ¹⁾	UMG511
1	33 03 072	Installation and commissioning instructions.
1	51 00 116	DVD/CD with the following contents: - Programming „GridVis“ software, - Functional descriptions, GridVis, UMG511, - UMG511, GSD file „U5110C2B.GSD“ for Profibus DP V0.
1	10 01 818	screw clamp, pluggable, 2 pin (auxiliary energy).
1	10 01 824	screw clamp, pluggable, 5 pin (voltage measurement 1-4).
1	10 01 822	screw clamp, pluggable, 8 pin (current measurement 1-4).
1	10 01 810	screw clamp, pluggable, 6 pin (digital outputs).
2	10 01 809	screw clamp, pluggable, 5 pin (digital inputs).
1	08 01 505	patch cable 2m, twisted, (connection UMG - PC/switch).
1	52 19 301	fixing clamps.

¹⁾ Article number - see delivery note.

Available accessories

Art.no.	Designation
13 10 539	Profibus plug, 9-pin DSUB, with integrated switchable terminating resistors.
29 01 903	Sealing, 144x144.

Description

Intended use

The UMG511 is intended for the measurement of voltage quality according to EN61000-4-30 in the building installation, to distributors, power switches and busbars.

Measurement voltages and measurement currents must come from the same network.

The UMG511 is suitable for installation in stationary and weather-protected control panels. Conductive control panels must be earthed.

The UMG511 can be used in 2, 3 and 4 conductor networks and in TN and TT networks.

The current measurement inputs of the UMG511 are connected using external $\dots/1A$ or $\dots/5A$ current converters.

Measurement in medium and high voltage networks generally takes place through current and voltage converters.

The UMG511 can be used in residential and industrial areas.

Measurement results can be displayed and saved then read out and processed further by serial interfaces.

Features of UMG511

- Front panel installation, 144x144mm,
- Working temperature range - 10°C .. +55°C,
- Colour graphics display 320x420, 256 colours, 6 push buttons
- 8 digital inputs, 5 digital outputs,
- 16Bit A/D converter, data memory 256MByte flash, SDRAM 32Mbyte,
- Continual scanning of voltage and current measurement inputs with 20kHz,
- Frequency of fundamental oscillation 15Hz..440Hz
- 4 voltage measurement inputs, 4 current measurement inputs,
- Measurement in TN and TT networks,
- RS485
 - Profibus DP/V0 (Option),
 - Modbus RTU, Modbus-Master, BACnet (Option)
- Ethernet Web-Server, EMAIL, BACnet (Option),
- Collection of transients >50µs and storage with up to 16000 scanning points,
- Collection of more than 2000 measurement values,
- Measurement of the power quality according to DIN EN61000-4-30, class A,
- Flicker measurement according to DIN EN61000-4-15:2011, class F1,
- Analysis and assessment according to DIN EN50160 with the GridVis programming software included in the delivery.
- Working measurement, measurement uncertainty according to DIN EN50470-3:
 - Class C for ../5A converter,
 - Class B for ../1A converter,
- Measurement of harmonics 1 to 63 according to DIN EN 61000-4-7 class 1 for
 - UII, UII, I, P (receipt/supply) and
 - Q (ind./cap.),
- Measur. of intermediate harmonics 1 to 63 for (UII, UII, I) according to DIN EN61000-4-7 cl. 1,
- programming of own applications in Jasic

Measurement process

The UMG511 measures without gaps and calculates all effective values over a 200ms interval.

The UMG511 measures the real effective value (TRMS) of the voltages and currents applied to the measurement inputs.

Operating concept

You can programme and call up measurement values with the UMG511 in a variety of ways.

- **Directly** on the device using 6 push buttons and the display.
- Using the **GridVis** programming software,
- Using the UMG511 **homepage** for devices with an Ethernet interface.
- Using the RS485 with the **modbus** protocol.
You can change and call up the data with the help of the modbus address list (stored on the enclosed data carrier).

This operating manual only describes operation of the UMG511 using the integrated display and the 6 push buttons.

The GridVis programming software and the homepage have their own „online help“.

Programming software „GridVis“

The UMG511 can be programmed and read out using the GridVis programming software included in the delivery. In order to do so, a PC must be connected to the UMG511 using a serial interface (RS485/Ethernet)



Fig. 13.2 connection of an UMG511 to a PC using an interface converter

Features of GridVis

- Programming the UMG511
- Configuration of recordings.
- Analysis of the read data according to EN 61000-2-4.
- Reading out recordings.
- Saving data in a database.
- Graphic presentation of measurement values.
- Programming special customer applications.

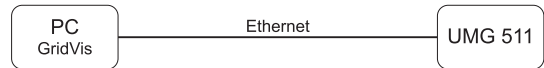

Fig. 13.3 connection of an UMG511 to a PC with Ethernet.

Assembly

Place of Installation

The UMG511 is suitable for installation in fixed, weather protected switch boards. Conducting switch boards have to be grounded.

Installation position

In order to achieve sufficient ventilation, the UMG511 has to be installed vertically. The clearance has to be at least 50mm at the top and bottom and 20mm at the side.

Front Board Cutout

Cutout size: $138^{+0,8} \times 138^{+0,8}$ mm

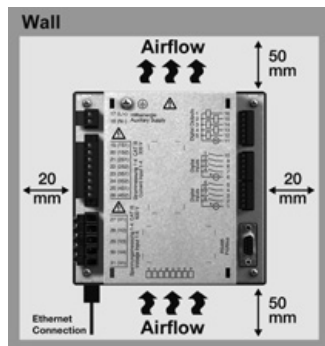

Fig. installation position of UMG511; view from behind.



Failure to comply with the minimum clearances can destroy the UMG511 in higher temperatures!

Ethernet Connection

The UMG511's Ethernet connection is located on the underside of the housing. Depending on the bending radius of the Ethernet cable and plug type, you must provide a connection area beneath the UMG511.

The connection area beneath the UMG511 should not be less than 50 mm.

Fixing

The UMG511 is fixed into the switch board with two fixing clips that are each mounted on the device at the top and bottom.

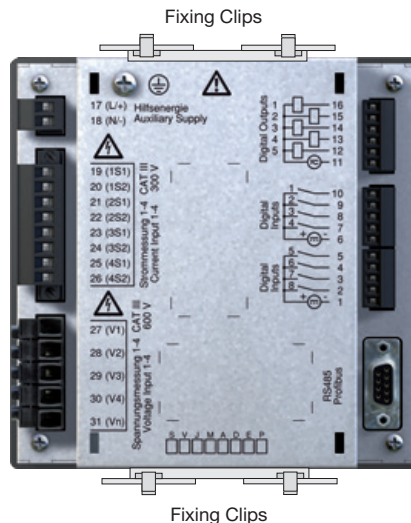
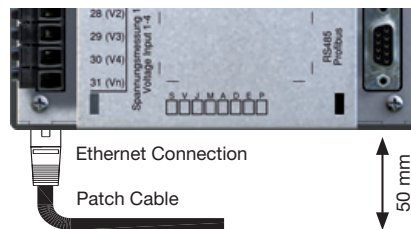

Installation

Protective Wire Connection

Use a ring cable lug for connecting the protective wire to the UMG511.

Supply Voltage

A supply voltage is required to operate the UMG511. The type and level of the necessary supply voltage is noted on the label.

Before applying the supply voltage, make sure that the voltage and the frequency match the details on the label!

The connection cables for the supply voltage must be connected using a fuse. Use a UL/IEC listed fuse.



Warning - danger of death!

It is necessary for the protective wire connection on the device to be connected with the system grounding.

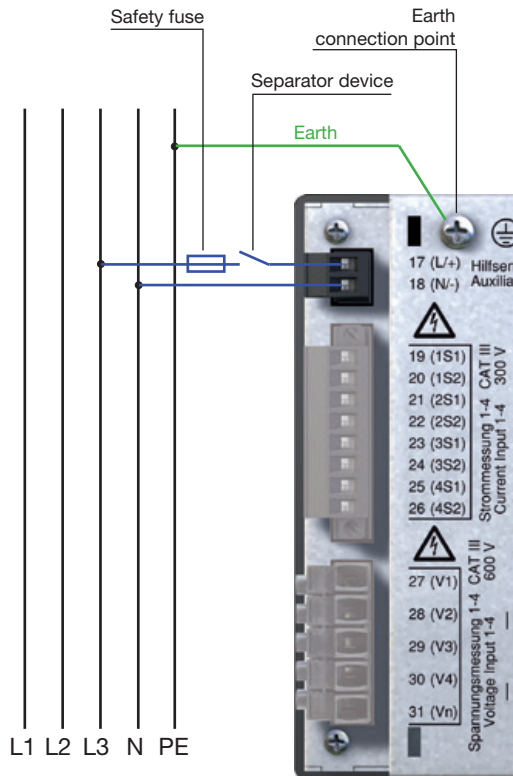

Fig. connection example of voltage supply to a UMG511.

**Warning!**

The inputs for the supply voltage are dangerous to touch!

**Warning!**

Please pay attention to the details on the supply voltage provided on the UMG511 label.



- An isolator or circuit breaker must be provided for the voltage supply in building installation.
- The isolator must be attached near to the device and must be easy for the user to access.
- The switch must be marked as a separator for this device.
- Voltages above the authorized voltage range can destroy the device.

Voltage measurement

Three-phase 4 conductor system

The UMG511 can be used in a three-phase 4 conductor system (TN, TT networks) with an earthed neutral wire. The bodies of the electrical systems are earthed.

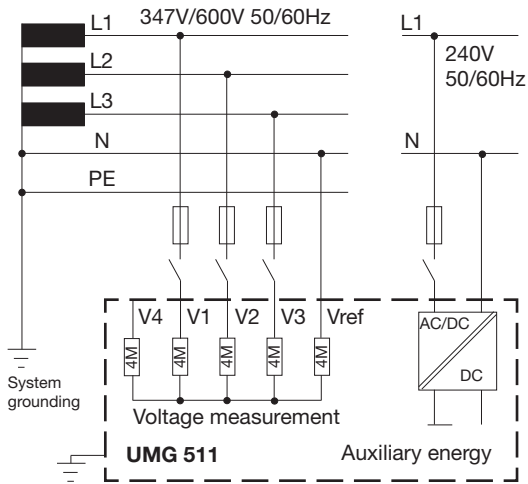

Fig. principle circuit diagram, UMG511 in the TN network.

Three-phase 3 conductor system

The UMG511 is only restrictedly suitable for use in IT networks because the measurement voltage is measured against the housing potential and the input impedance of the device causes a leakage current against earth. The leakage current can cause the insulation monitoring in IT networks to respond.

The connect variations with voltage converter are suitable for use in IT networks without any restrictions.

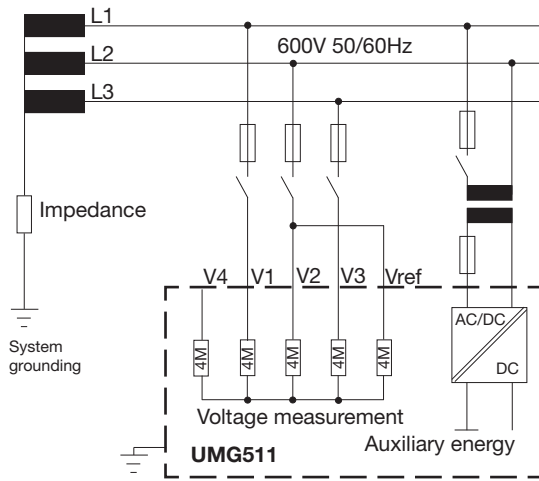

Fig. principle circuit diagram, UMG511 in the IT network without N.

Nominal voltages

List of networks and their nominal network voltages in which the UMG511 can be used.

Three-phase 4 conductor systems with grounded neutral wire.

U_{L-N} / U_{L-L}	
66V / 115V	
120V / 208V	
127V / 220V	
220V / 380V	
230V / 400V	
240V / 415V	
260V / 440V	
277V / 480V	Maximum nominal voltage of the network according to UL
347V / 600V	
400V / 690V	Maximum nominal voltage of the network
417V / 720V	

Fig. table of suitable network nominal voltages for voltage measurement inputs according to EN60664-1:2003.

Ungrounded three-phase 3 conductor systems.

U_{L-L}	
66V	
115V	
120V	
127V	
200V	
220V	
230V	
240V	
260V	
277V	
347V	
380V	
400V	
415V	
440V	
480V	
500V	
577V	Maximum nominal voltage of the network
600V	

Fig. table of suitable network nominal voltages for voltage measurement inputs according to EN60664-1:2003.

Voltage measurement inputs

The UMG511 has 4 voltage measurement inputs (V1, V2, V3, V4)

Excess voltage

The voltage measurement inputs are suitable for measurement in networks in which overvoltages of the overvoltage category 600V CATIII occur.



For measurement with the auxiliary measurement (V4), a voltage must be connected to the baseline measurement for frequency determination.



In case of a three wire main measurement (input V1-V3), the auxiliary measurement (input V4) cannot be used as measuring input.

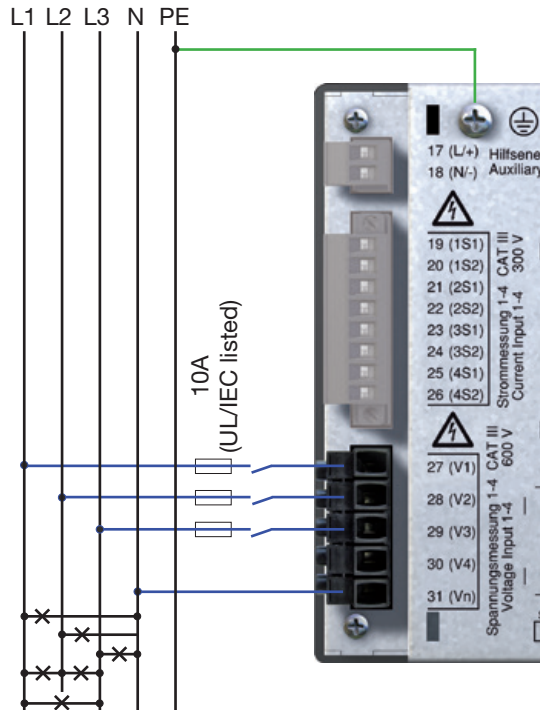

Fig. connection example for voltage measurement

When connecting the voltage measurement, the following must be observed:

- In order to disconnect the voltage and current, a suitable circuit breaker is to be provided
- The circuit breaker must be positioned near to the UMG511, identified for the user and easy to reach.
- Only use authorised UL/IEC excess current protection devices and circuit breakers 10A (type C).
- The excess current protection device must have a nominal value which is measured for the short circuit current at the connection point.
- Measurement voltages and measurement currents must come from the same network.

**Caution!**

Voltages that exceed the permitted nominal network voltages must be connected using a voltage converter.

**Caution!**

The UMG511 is not suitable for measuring DC voltages.

**Caution!**

Contact with the voltage measurement inputs on the UMG511 is dangerous!

**Caution!**

The voltage measurement inputs may not be used for voltage measurement in SELV circuits (low voltage protector).

Main measurement, inputs 1-3

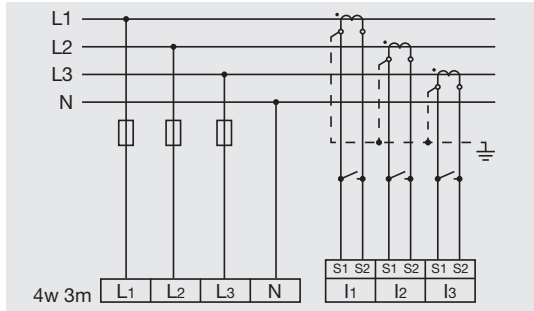

Fig. measurement in a three-phase 4 conductor network with asymmetrical load.

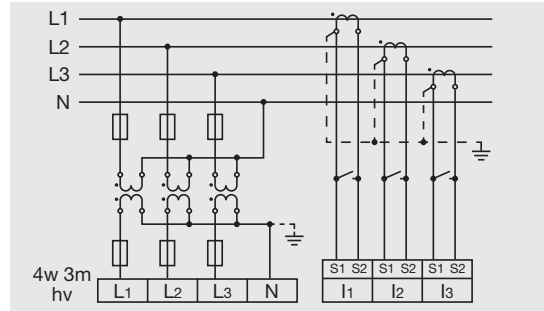

Fig. measurement using 3 voltage converters in a three-phase 4 conductor network with asymmetrical load.

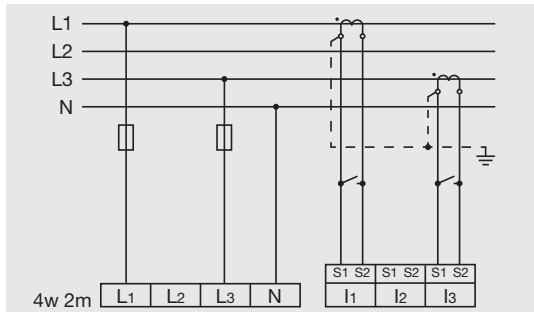

Fig. measurement using a three-phase 4 conductor network with symmetrical load.

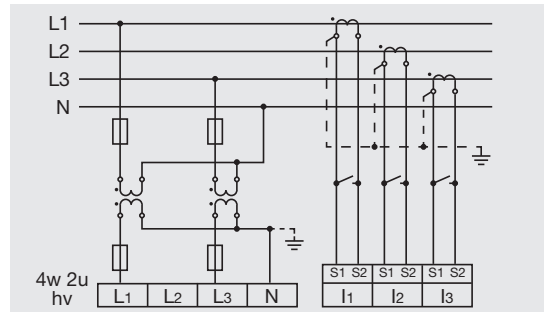

Fig. measurement using 2 voltage converters in a three-phase 4 conductor network with asymmetrical load.

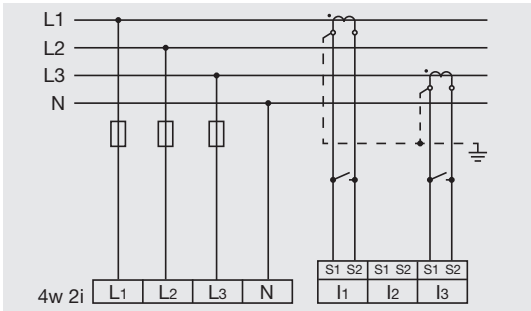

Fig. measurement using 2 current converters in a three-phase 3 conductor network with symmetrical load.

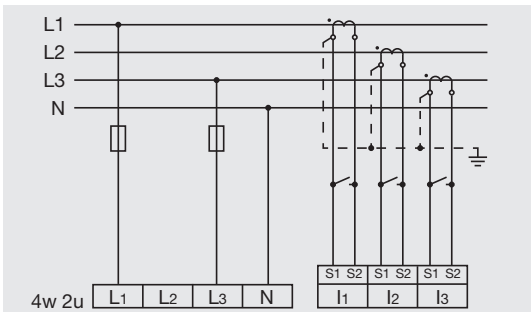

Fig. measurement in a three-phase 4 conductor network with asymmetrical load.

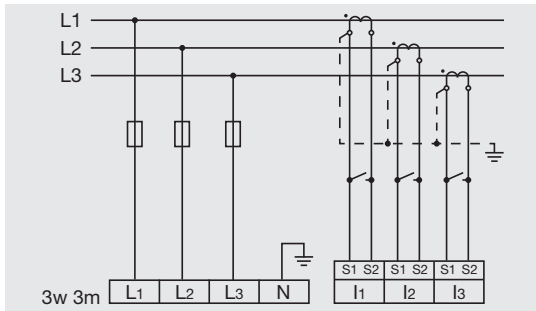

Fig. measurement in a three-phase 3 conductor network with asymmetrical load.

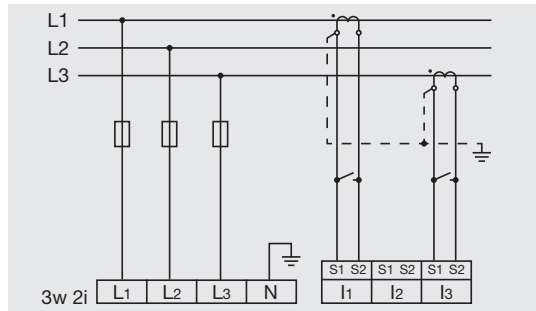

Fig. measurement in a three-phase 3 conductor network with asymmetrical load.

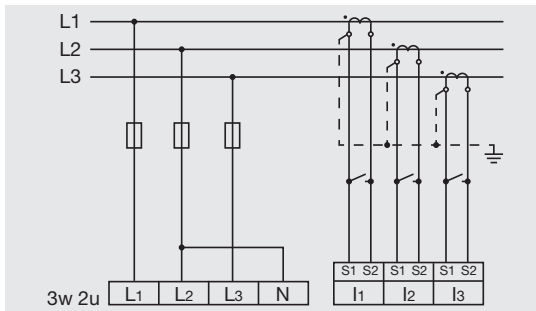

Fig. measurement in a three-phase 3 conductor network with asymmetrical load.

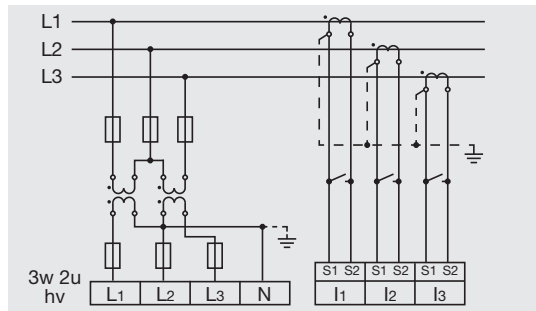

Fig. measurement in a three-phase 3 conductor network with asymmetrical load.

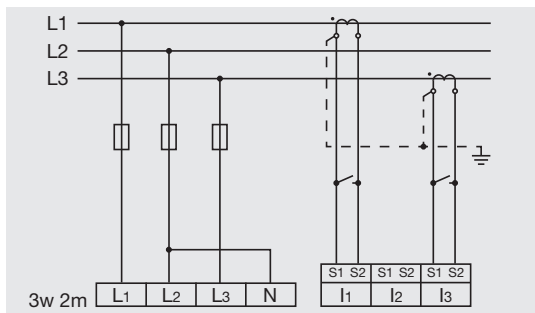

Fig. measurement in a three-phase 3 conductor network with asymmetrical load.

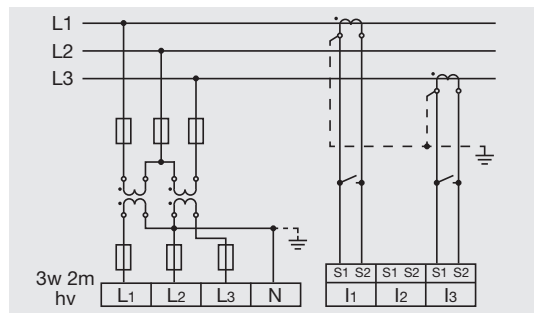

Fig. measurement in a three-phase 3 conductor network with asymmetrical load.

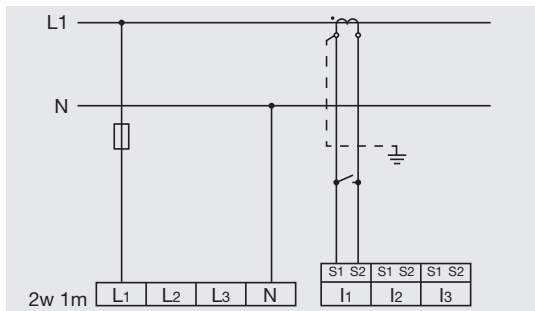

Fig. measurement of a phase in a three-phase 4 conductor network.

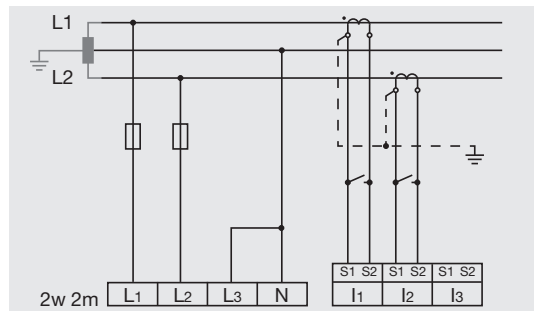

Fig. measurement in a single-phase 3 conductor network. I3 and U3 are not calculated and set to zero.

Auxiliary measurement, input 4

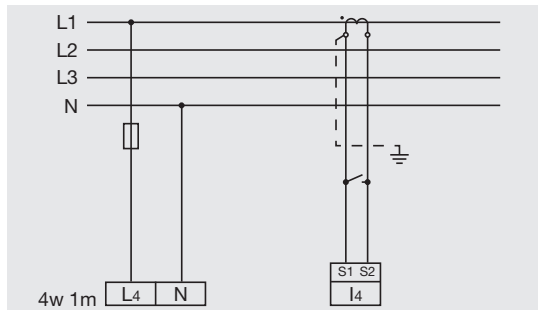

Fig. measurement using a three-phase 4 conductor network with symmetrical load.

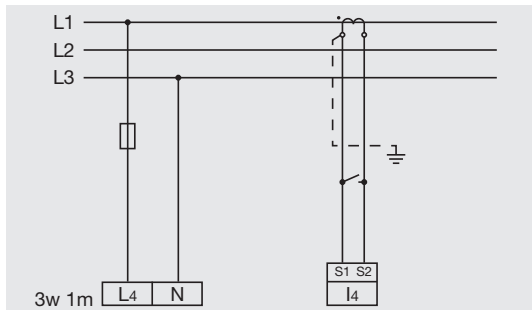

Fig. measurement in a three-phase 3 conductor network with symmetrical load.

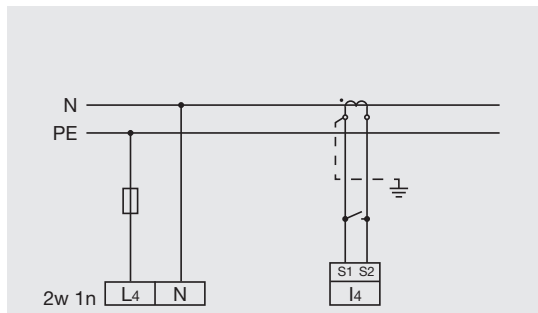

Fig. measurement of the voltage between N and PE. Measurement of the current in the neutral wire.



In case of a three wire main measurement (input V1-V3), the auxiliary measurement (input V4) cannot be used as measuring input.



For measurement with the auxiliary measurement (V4), a voltage must be connected to the baseline measurement for frequency determination.

Frequency measurement

The UMG511 needs the network frequency to measure and calculate measurement values. The network frequency must be in a range between 15Hz and 440Hz.

For automatic ascertainment (wide range) of the frequency, an L1-N voltage larger than 10Veff must be applied to the voltage measurement input V1.

The measurement of power frequency happens only at the measuring inputs of the main measurement (V1, V2, V3).



Measurement voltages and measurement currents must come from the same network.

Current measurement

The UMG511 is designed for the connection of current converters with secondary currents of $\dots/1A$ and $\dots/5A$. Only AC currents, and no DC currents, can be measured.

Each current measurement input can be loaded with 120A for 1 second.



Caution!

Contact with the current measurement inputs is dangerous!



Caution!

The UMG511 is not suitable for measuring DC voltages.



Earthing current converters!

If a connection is foreseen for earthing the secondary winding, this must be connected to earth.

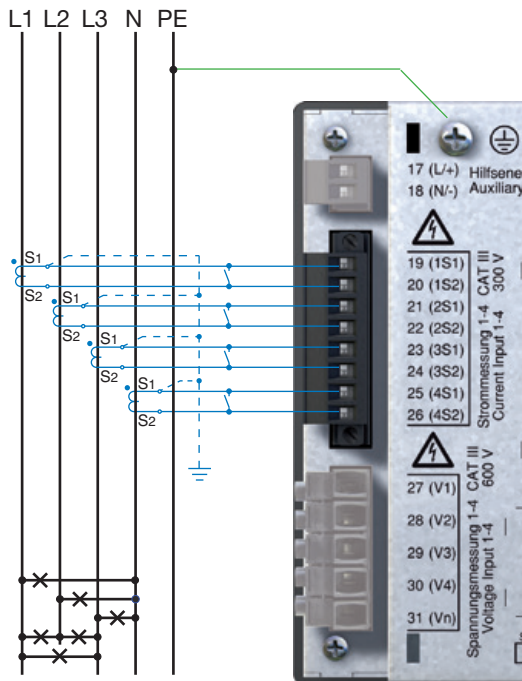

Fig. connection example, current measurement using current converters.

Current direction

The current direction can be individually corrected on the device using the available serial interfaces for each phase.

If connected incorrectly, subsequent reconnection of the current converters is not necessary.



Open current converters!

Voltage peaks that are dangerous to touch can occur to current converters that are operated with the secondary side open!

With „open-protected“ current converters, the winding insulation is measured so that the current converters can be operated open. However, these current converters are also dangerous to touch when operated open.



Current converter connections!

The secondary connections of the current converter must be short-circuited to these before the electricity cables are disconnected from the UMG511!

If a test switch is available which automatically short-circuits the current converter secondary cables, it is sufficient to put these in the „test“ position, if the short-circuiters have been tested beforehand.

Differential current measurement

If the current measurement is taken using two current converters, the overall translation ratio of the current converters must be programmed in the UMG511.

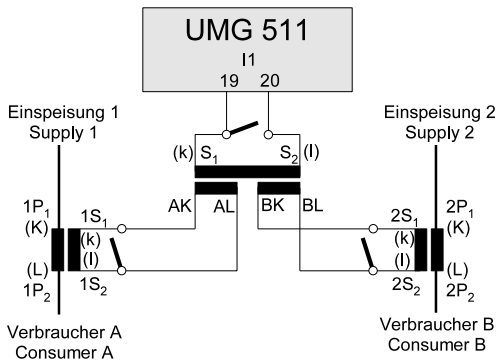

Fig. example of current measurement using a differential current converter.

Example:

The current measurement takes place using two current converters. Both current converters have a translation ratio of 1000/5A. Differential measurement is carried out with a differential current converter 5+5/5A.

The UMG511 must then be set as follows:

Primary current: $1000A + 1000A = 2000A$

Secondary current: $5A$

Direct measurement

Nominal currents up to 5A can also be directly measured with the UMG511.

Under consideration that the direct measurement will be carried out for the current only in three phase 4 wire systems with mains voltage till

- 127V/220V (300V CAT III) according UL
- 277V/480V (300V CAT III)

and three phase 3 wire systems with mains voltage till

- 277V (300V CAT III) according UL
- 480V (300V CAT III)

Due to the fact that the UMG511 does not have integrated protection for the current measurement, this protection must be foreseen in the installation.

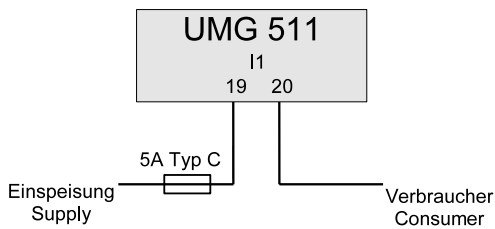

Fig. example of direct current measurement.

Ampere meter

If you want to measure the current not only with the UMG511, but also with an additional ampere meter, the ampere meter must be switched in series to the UMG511.

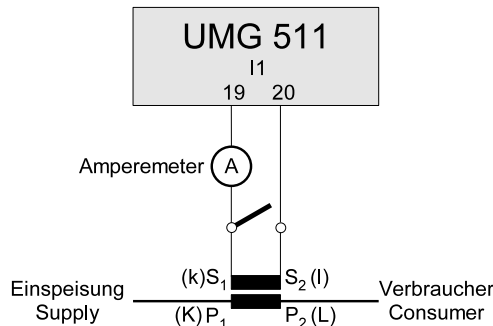

Fig. example of current measurement with an additional ampere meter.

RS485

The RS485 interface on the UMG511 is designed as a 9-pin DSUB socket.

On this interface, the UMG511 supports the following selected protocols:

- Modbus RTU
- Profibus DP V0 Slave (Option)

For connection, we recommend a 9-pin profibus (modbus) plug e.g. the company Phoenix, type „SUBCON-Plus-ProfiB/AX/SC“ with the article number 2744380 (Janitza article no. 13.10.539).

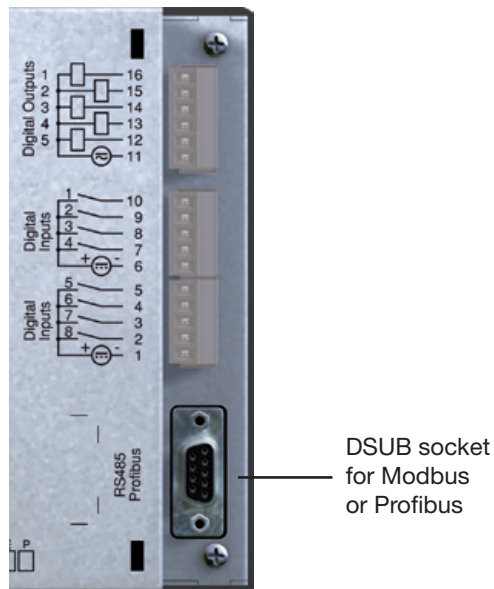

Fig. UMG511 with DSUB socket for the RS485 interface.

Connection of bus cables

The incoming bus cable is connected to clamps 1A and 1B. The bus cable for the next device in the line is connected to clamps 2A and 2B. If no device follows in the line, the bus cable must be terminated with resistors (switch to ON).

In the ON switch position, the clamps 2A and 2B are switched off for the continuing bus cable.

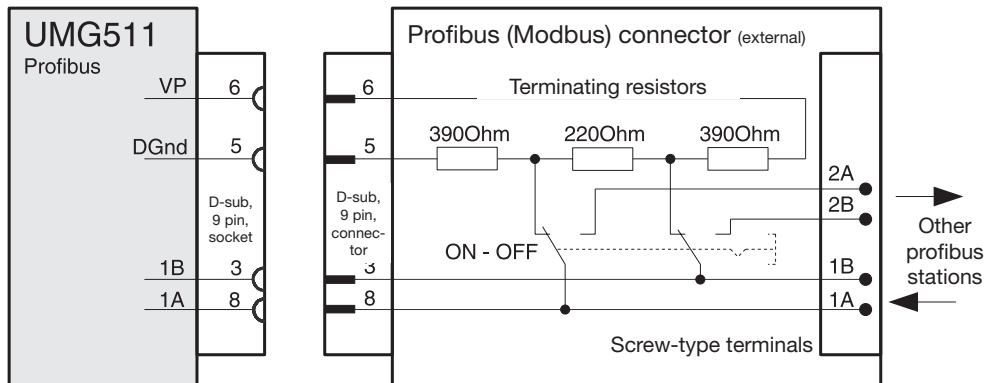

Fig. profibus plug with terminal resistors.

Shields

A twisted, shielded cable is foreseen for connections using the RS485 interface.

- Ground the shields of all cables leading to the cabinet at the cabinet entry point.
- Connect the shield extensively and with good conductivity with a low external voltage ground.
- Intercept the cable mechanically above the ground clip in order to avoid damages caused by cable movements.
- Use suitable cable insert guides, such as PG glands, to guide the cable into the switch cabinet.

Cable type

The cables used must be suitable for an environmental temperature of at least 80°C.

Recommended cable types:

Unitronic Li2YCY(TP) 2x2x0.22 (Lapp cable)

Unitronic BUS L2/FIP 1x2x0.64 (Lapp cable)

Maximum cable length

1200m at a Baud rate of 38.4k.

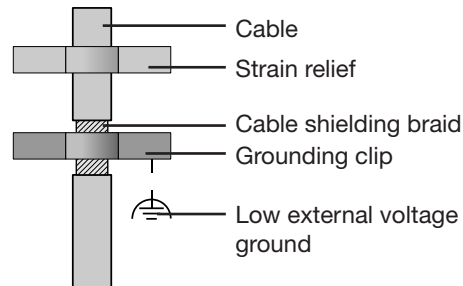

Fig. Shielding arrangement at cabinet entry point.

Terminal resistors

The cable is terminated with resistors (120Ohm 1/4W) at the beginning and end of a segment.

The UMG511 does not have any terminal resistors.



For the wiring of the Modbus connection, CAT cables are not suitable. Please use the recommended cables.

Bus structure

- All devices are connected in a bus structure (line).
- In one segment, up to 32 participants can be switched together.
- The cable is terminated with resistors at the beginning and end of a segment.
- Repeaters (power boosters) must be used with more than 32 participants in order to connect the individual segments.
- Devices with terminated resistor have to be supplied.
- We recommend to install the master UMG at the end of the segment.
- In case that the master UMG with terminated bus resistor will be removed, the bus is not under operation.
- In case that slave UMG with terminated bus resistor will be removed or is not switched on, the bus is can be unstable.
- UMGs which have no termination can be replaced without any interruption of the bus.

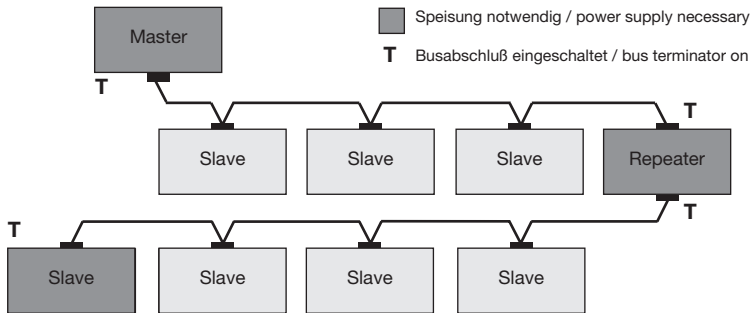
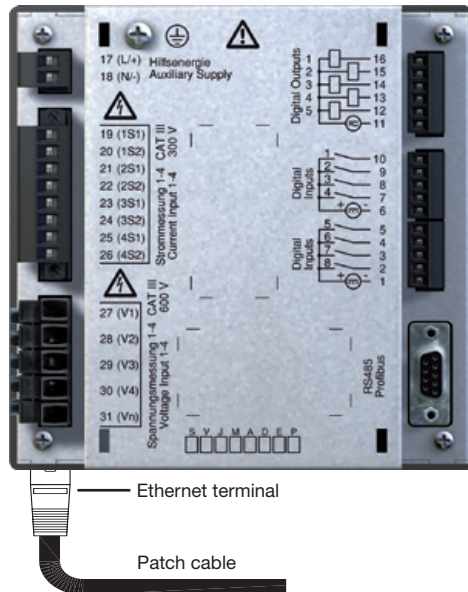

Fig. schema bus structure

Ethernet

The network settings for the Ethernet are specified by the network administrator and set on the UMG511 correspondingly.

If the network settings are not known, the patch cable may not be inserted into the UMG511.



Caution!

Incorrect network settings can cause disturbances in the network!

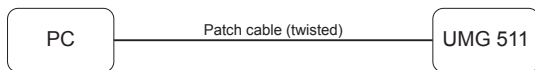

*Fig.
connection example; direct connection between
UMG511 and PC using a twisted patch cable (art.
no 08.01.505).*

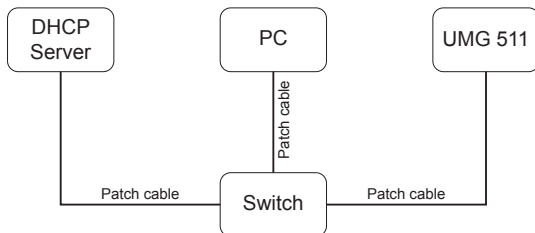

*Fig.
connection example; UMG511 and PC receive the
IP address automatically allocated by a DHCP ser-
ver.*

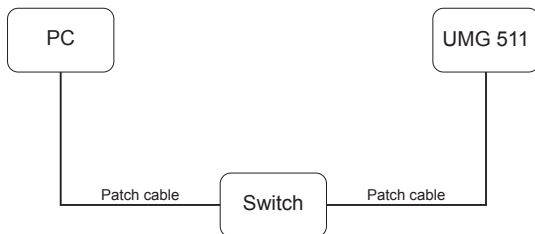

*Fig.
connection example; UMG511 and PC require a
fixed IP address.*

Digital outputs

The UMG511 has 5 digital outputs. These outputs are galvanically separated from the analysis electronics using optocouplers. The digital outputs have a joint reference.

- The digital outputs can switch AC and DC loads.
- The digital outputs are not short-circuit proof.
- Connected cables that are longer than 30m must be shielded when laid.

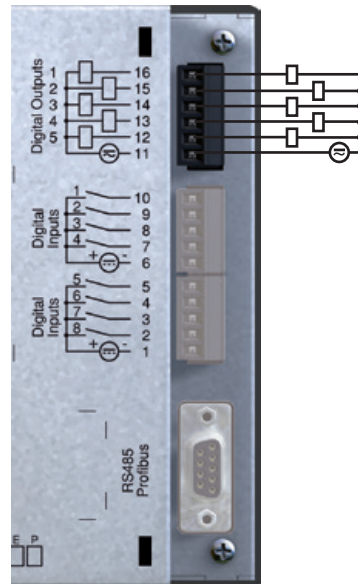

Fig. connection of digital outputs

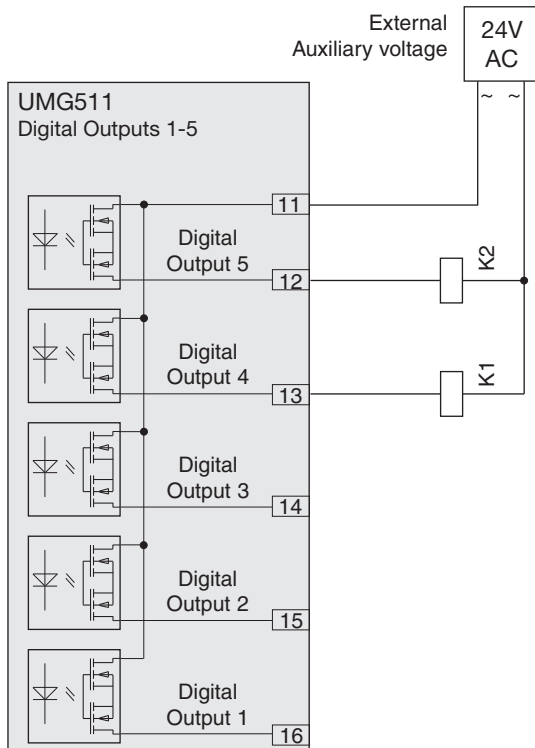

Fig. connection of two relays to the digital outputs 4 and 5.

Digital inputs

The UMG511 has 8 digital inputs. The digital inputs are divided into two groups, each with 4 inputs. Each group has a joint reference.

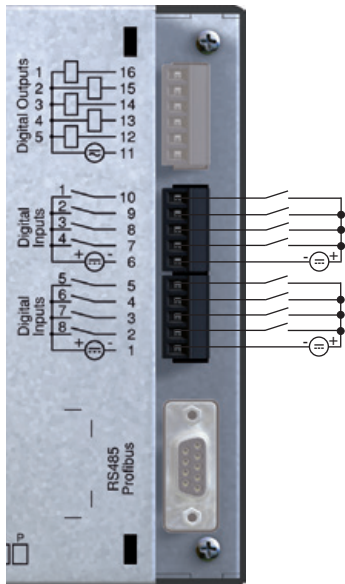

Fig. example of the connection of digital inputs

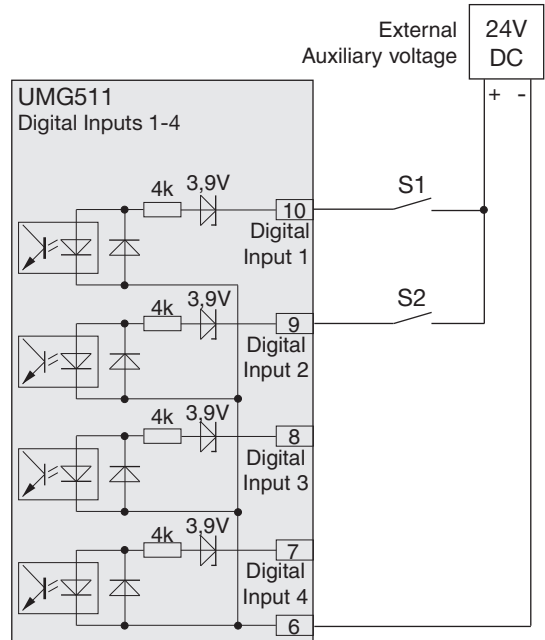

Fig. example for the connection of the external contacts S1 and S2 to the digital inputs 1 and 2.

S0 impulse input

You can connect a S0 pulse generator according to DIN EN62053-31 on each digital input. You require an external auxiliary voltage with an output voltage in the range of 20 .. 28V DC and a resistance of 1.5kOhm.

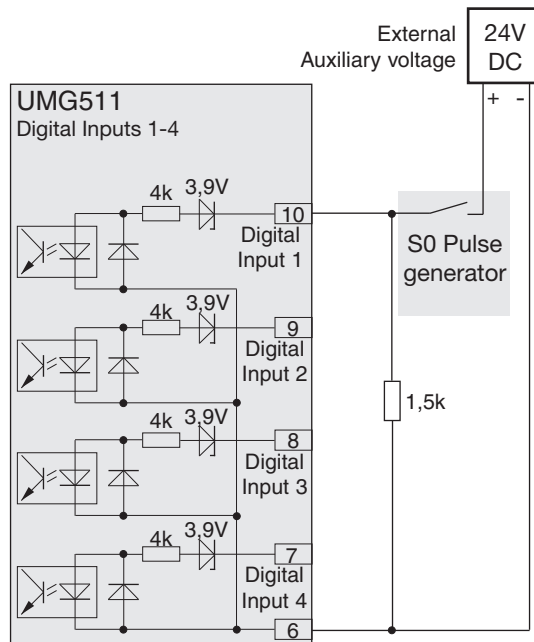

Fig. example for the connection of a S0 pulse generator to digital output 1.

Operation





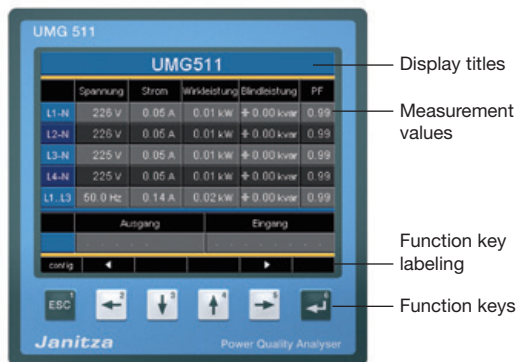

The UMG511 is operated using six function keys.

The six keys are allocated different functions depending on the context:

- Selection of measurement value displays.
- Navigation within the menu.
- Processing the device settings.



Explanation of buttons

Button	Function
	<ul style="list-style-type: none"> • Return to first screen (Home) • Exit menu
	<ul style="list-style-type: none"> • Select number • Select main values (U, I, P ...)
	<ul style="list-style-type: none"> • Change (number -1) • Select secondary values • Select menu point
	<ul style="list-style-type: none"> • Change (number +1) • Select secondary values • Select menu point
	<ul style="list-style-type: none"> • Select number • Select main values (U, I, P ...)
	<ul style="list-style-type: none"> • Open selection menu • Confirm selection

Measurement value displays

Main values

You can use keys 2 and 5 to browse between the main values of the measurement value displays (see page 100-103).

Auxiliary values

You can use keys 3 and 4 to browse between the auxiliary values of a measurement value display (see page 100-103).

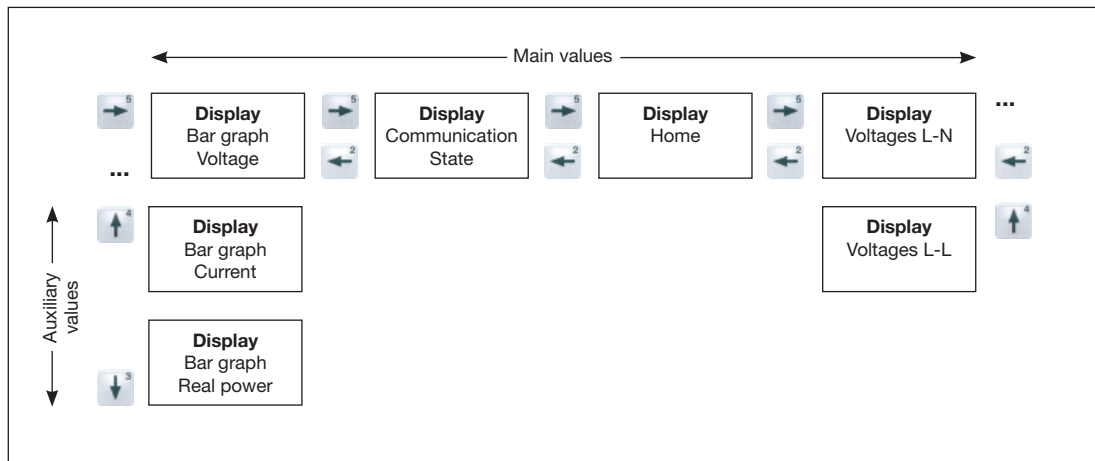

„Home“ measurement value display

Once the network returns, the UMG511 starts with the „Home“ measurement value display.

This measurement value display contains the device names and an overview of important measurement values. The device name consists of the device type and serial number upon delivery.

UMG511-51101480					
	Voltage	Current	Real Power	Reactive Pw.	PF
L1-N	222 V	0.05 A	0.01 kW	± 0.00 kvar	0.99
L2-N	222 V	0.05 A	0.01 kW	± 0.00 kvar	0.99
L3-N	222 V	0.05 A	0.01 kW	± 0.00 kvar	0.99
L4-N	222 V	0.05 A	0.02 kW	± 0.00 kvar	0.99
L1..L3	50.0 Hz	0.14 A	0.02 kW	± 0.00 kvar	0.99
Dig. Output			Dig. Input		
.		
config ◀ ▶					

home

ESC

Using the „Home - Key 1“, you come out of the measurement value displays for the main values directly to the first „Home“ measurement value display.

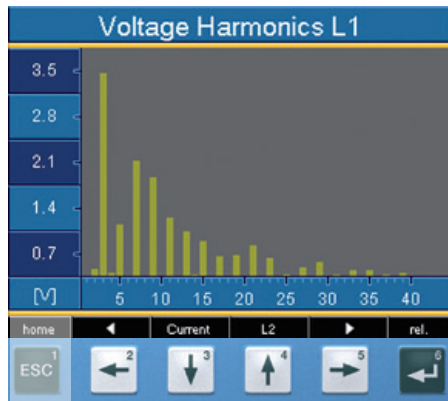

Select measurement value display

You want to change to a measurement value display with main values.

- Use the function keys 2 and 5 to browse between the measurement value displays of the main values.
- With function key 1 (Home), you always access the first measurement value display.

You want to change to a measurement value display with auxiliary values.

- Select the measurement value display with the main values.
- Select the measurement value display with function keys 3 and 4 for the auxiliary values.

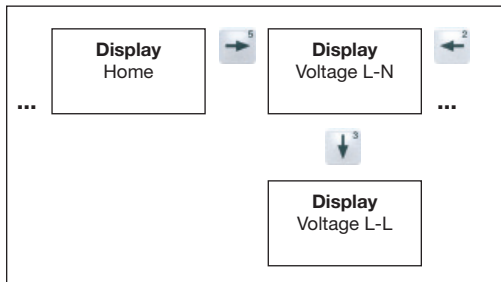

Example: selection of auxiliary value voltage.

Voltage L-N			
	Value	Min Value	Max Value
L1-N	222.7 v	216.0 v	234.0 v
L2-N	222.7 v	213.1 v	234.1 v
L3-N	222.6 v	213.0 v	233.9 v
L4-N	222.6 v	213.0 v	234.0 v

home ← L-L → select

ESC 1 ← 2 ↓ 3 ↑ 4 → 5 ← 6

↓

Voltage L-L			
	Value	Min Value	Max Value
L1-L2	387.0 v	290.7 v	406.5 v
L2-L3	386.9 v	367.9 v	405.0 v
L3-L1	386.3 v	348.3 v	406.7 v
L4-N	0.4 v	0.4 v	0.5 v

home ← L-N → select

Call up additional information

- Browse with keys 2 to 5 to the required measurement value display.
- Activate the measurement value selection with key 6 (selection)..
- The background colour for the measurement value changes from grey to green.
- The additional information is shown in a blue window.
- Select the required measurement value with keys 2 to 5.
- End the process with key 1 (ESC) or select another measurement value with keys 2 to 5.

Voltage L-N			
	Value	Min Value	Max Value
L1-N	222.7 v	216.0 v	234.0 v
L2-N	222.7 v	213.1 v	234.1 v
L3-N	222.6 v	213.0 v	233.9 v
L4-N	222.6 v	213.0 v	234.0 v

home ← L-L → select

ESC ← 2 ↓ 3 ↑ 4 → 5 ↵ 6

Voltage L-N			
	Value	Min Value	Max Value
L1-N	221.4 v	216.0 v	234.0 v
L2-N	THD 2.3 % Power Factor 1.00 Frequency 50.00 Hz	13.1 v	234.1 v
L3-N	221.3 v	213.0 v	233.9 v
L4-N	221.3 v	213.0 v	234.0 v

esc ← ↓ ↑ →

Delete min/max values individually

- Use keys 2 to 5 to browse to the required measurement value display.
- Activate the measurement value selection with key 6 (selection).
- The background colour for the measurement value changes from grey to green.
- Select the required minimum and maximum value with keys 2 to 5.
- The point with the date and time of occurrence is shown in an additional blue window.
- You can now delete the selected min or max value with key 6 (reset).
- End the process with key 1 (ESC) or select another min/max value with keys 2 to 5.

Voltage L-N			
	Value	Min Value	Max Value
L1-N	222.7 v	216.0 v	234.0 v
L2-N	222.7 v	213.1 v	234.1 v
L3-N	222.6 v	213.0 v	233.9 v
L4-N	222.6 v	213.0 v	234.0 v

home ← L-L → select

ESC 1 ← 2 ↓ 3 ↑ 4 → 5 ← 6

Voltage L-N			
	Value	Min Value	Max Value
L1-N	221.5 v	216.0 v	234.0 v
L2-N	221.5 v	213.1 v	234.1 v
L3-N	221.4 v	213.0 v	233.9 v
L4-N	221.4 v	213.0 v	234.0 v

esc ← ↓ ↑ → reset



The date and time for the min/max values are shown in UTC time (co-ordinated world time).

List of transients

Recognized transients are listed in the transients list.

- The transients list consists of 2 pages.
- Transients 1 to 8 are listed on page 1 and 9 to 16 on page 2.

Display transients

- Browse with keys 2 or 5 to the main value display „Transients“.
- Select with key 4 the required page.
- Go to the transients list with key 6 (select), and select a transient with keys 3 or 4.
- Allow to the transients to be presented graphically with key 6 (enter).
- Show or hide the legends with key 6 (legends).
- You can exit the graphic presentation of the transients with key 1 (esc).

Transient voltages are quick, impulsive transient oscillation processes in electrical networks.

Transient voltages are not predictable with respect to time and have a limited period.

Transient voltages are caused by the effects of lighting, by switching operations or by triggered fuses.

Transients (1..8)		
Phase	Reason	Date/Time
L1	delta	2011 Mar 16 15:33:07,122
L4	delta	2011 Mar 16 15:32:29,826
L3	delta	2011 Mar 16 15:32:29,819
L2	delta	2011 Mar 16 15:32:29,813
L2	delta	2011 Mar 16 15:32:29,806
L1	delta	2011 Mar 16 15:32:29,799
L4	delta	2011 Mar 16 15:32:29,793
L3	delta	2011 Mar 16 15:32:29,786

Navigation controls: ESC (1), ← (2), ↓ (3), ↑ (4), → (5), ↶ (6)

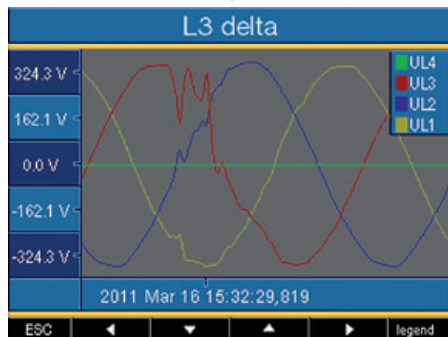

List of events

Recognized events are listed in the events list.

- The events list consists of 2 pages.
- Events 1 to 8 are listed on page 1 and events 9 to 18 on page 2.

Display incident

- Browse with keys 2 or 5 to the main value display „Transients“.
- Select with key 4 the required page.
- Go to the events list with key 6 (select) and select an event with keys 3 or 4.
- Allow the incident to be graphically presented with key 6 (enter).
- Show or hide the legends with key 6 (legends).
- You can exit the graphic presentation of the transients with key 1 (esc).

Events (1..8)		
Phase	Reason	Date/Time
L4	U MAX	2011 Mar 16 15:32:29,950
L2	U MAX	2011 Mar 16 15:32:29,950
L3	U MAX	2011 Mar 16 15:32:29,950
L1	U MAX	2011 Mar 16 15:32:29,950
L4	U MAX	2011 Mar 16 15:32:29,867
L3	U MAX	2011 Mar 16 15:32:29,867
L2	U MAX	2011 Mar 16 15:32:29,867
L1	U MAX	2011 Mar 16 15:32:29,867

home ← 9..16 → select

ESC 1 ← 2 ↓ 3 ↑ 4 → 5 ← 6

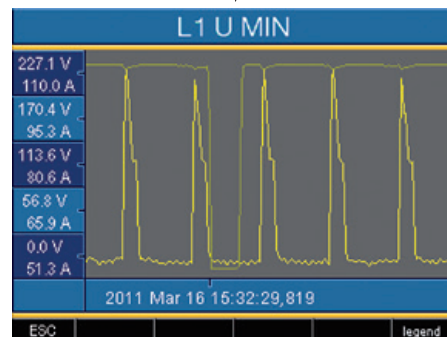

Events are limit value violations of effective current and voltage values.

Configuration

The supply voltage must be connected for configuration of the UMG511.

Apply supply voltage

- The level of supply voltage for the UMG511 can be taken from the label.
- After applying the supply voltage, a startup screen appears on the display. Approximately ten seconds later, the UMG511 changes to the first „Home“ measurement value display.
- If a display does not appear, check whether the applied supply voltage is within the nominal voltage range.

UMG511-51101480					
	Voltage	Current	Real Power	Reactive Pw.	PF
L1-N	222 V	0.05 A	0.01 kW	± 0.00 kvar	0.99
L2-N	222 V	0.05 A	0.01 kW	± 0.00 kvar	0.99
L3-N	222 V	0.05 A	0.01 kW	± 0.00 kvar	0.99
L4-N	222 V	0.05 A	0.02 kW	± 0.00 kvar	0.99
L1..L3	50.0 Hz	0.14 A	0.02 kW	± 0.00 kvar	0.99
	Dig. Output		Dig. Input		
		
config	←			→	

Illu. Example of „Home“ measurement value.



Warning!

Supply voltages that do not correspond with the label details can lead to incorrect functions and damage to the device.

Configuration menu

Once the network returns, the „Home“ measurement value display is found on the start page.

- Browse to the menu configuration with key 1.

If you are in a measurement value display for main values, you use key 1 - „Home“ to directly access the first „Home“ measurement display. Open the configuration menu with key 1. Select with key 3 or 4 the required sub menu and activate the selection with key 6 (enter).

Language

You can set the language for the measurement value displays and menus directly in the „configuration“ menu.

There are different languages to select between. The preset language in the factory is „English“.

If the language field is marked green, then the desired language can be selected by means of key 6 (enter) and the keys 3 or 4. Pressing the 6 key (enter) once more serves to confirm the selection and change the language.

UMG511-51101480					
	Voltage	Current	Real Power	Reactive Pw.	PF
L1-N	222 V	0.05 A	0.01 kW	± 0.00 kvar	0.99
L2-N	222 V	0.05 A	0.01 kW	± 0.00 kvar	0.99
L3-N	222 V	0.05 A	0.01 kW	± 0.00 kvar	0.99
L4-N	222 V	0.05 A	0.02 kW	± 0.00 kvar	0.99
L1..L3	50.0 Hz	0.14 A	0.02 kW	± 0.00 kvar	0.99
Dig. Output			Dig. Input		
config			← 2 →		
ESC 1			↓ 3 ↑ 4 → 5 ← 6		

Main menu	
Language	English
Communication	->
Measurement	->
System	->
Display	->
Colors	->
Extensions	->
esc	enter

Communication

The UMG511 has an Ethernet and a RS485 interface.

Ethernet (TCP/IP)

Select the type of address allocation for the Ethernet interface here.

DHCP mode

- **OFF** - IP address, Netmask and Gateway are specified by the user and set directly on the UMG511. Select this mode for simple networks without a DHCP server.
- **BOOTP** - BootP permits the fully automatic integration of a UMG511 in an existing network. BootP is an older protocol and does not have DHCP's extent of functions.
- **DHCP** - Upon starting, the UMG511 automatically collects the IP address, the Netmask and the Gateway from a DHCP server.

Factory pre-setting: **DHCP**



The UMG511 may only be connected to the Ethernet after coordinating with the network administrator!

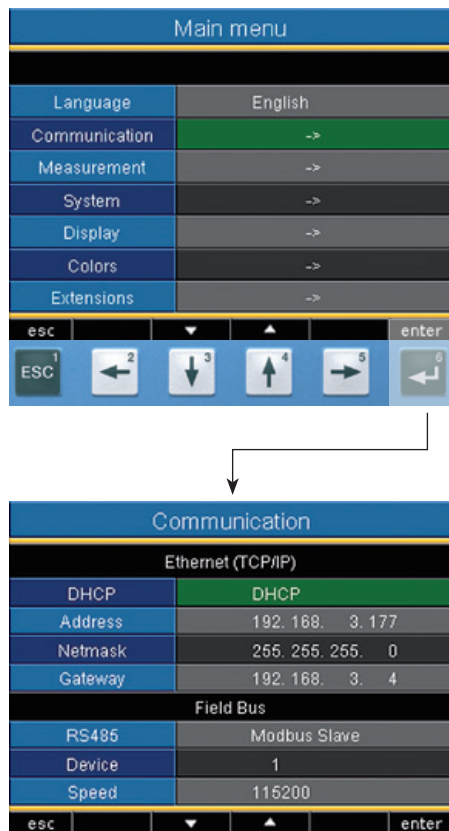

RS485

You can specify the protocol, device address and baud rate for operation with the RS485 interface. The device address is to be uniquely assigned within the bus structure; the baud rate specification is to be selected uniformly.

The corresponding field can be selected via the keys 3 or 4 (green marking). Key 6 (enter) enables you to access the selection options, which can then be selected with key 3 or 4. Pressing the 6 key (enter) once more serves to confirm the selection.

Protocol

Selection options:

- Modbus Slave
- Modbus Master/Gateway (factory pre-setting)
- Profibus DP V0 (Option)

Device address

Setting range: 0 - 255

Factory pre-setting: 1

Baud rate

Setting range: 9600, 19200, 38400, 57600,
115200 (factory pre-setting),
921600 kbps

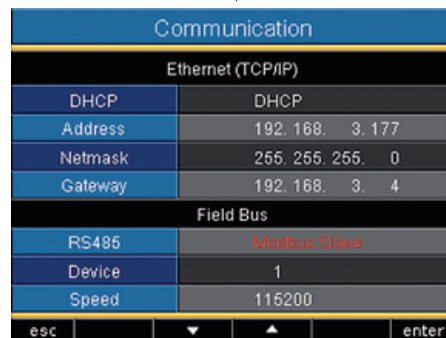
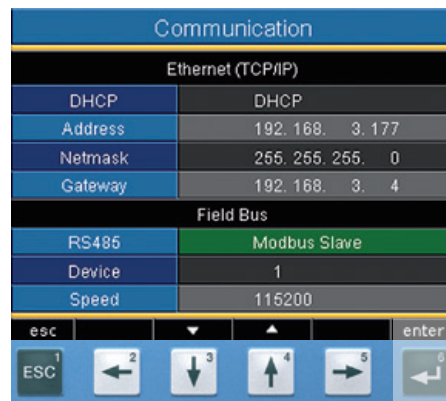

Measurement

Measurement			
Transformer	->		
Transients	->		
Events	->		
Voltage mode	L-N		
Rated Freq.	50 Hz (fixed frequency)		
Flicker	230V/50Hz		
esc	▼	▲	enter

Configure here:

- The measurement transformers for the current and voltage measurement
- The record of transients
- The recording of events
- The voltage mode
- The rated frequency
- The flicker setting

The UMG511 has 4 measurement channels for current measurement (I1..I4) and 4 measurement channels for voltage measurement (V1..V4 against Vref).

Measurement voltages and measurement currents for measurement channels 1-4 must come from the same network.

Main measurement

Measurement channels 1-3 are part of the main measurement. Use measurement channels 1-3 in three-phase systems.

Auxiliary measurement

Measurement channel 4 only belongs to auxiliary measurement. Use measurement channel 4 for measurements in single-phase systems or in three-phase systems with symmetric load.

The settings for the frequency and the relevant voltage are automatically taken over from the settings for the main measurement.

Current transformer

You can allocate both the main measurement and auxiliary measurement current transformer relations.

Select setting 5/5A for direct measurement of currents.

Setting range:

Primary	1 .. 1000000
Secondary	1 .. 5

Factory pre-setting:

Primary	5
Secondary	5

Nominal current

The nominal current determines the values which

- overcurrent
 - current transients
 - K-factors and the
 - automatic graphics scaling
- relate to.

Setting range: 0 .. 1000000A

Transformer MAIN		
	primary	secondary
Current Transf.	5A	5A
Voltage Transf.	400V	400V
Rated Current	5A	
Rated Voltage	230V	
Apply to AUX	No	
Connection	4w3m	
esc ▾ ▲ enter		

Transformer MAIN		
	primary	secondary
Current Transf.	5A	5A
Voltage Transf.	400V	400V
Rated Current	5A	
Rated Voltage	230V	
Apply to AUX	No	
Connection	4w3m	
esc ▾ ▲ enter		

Voltage transformer

You can allocate the main measurement and the auxiliary measurement of voltage transformer ratios accordingly.

For measurements without a voltage transformer, select the setting 400/400V.

Setting range:

Primary	1 .. 1000000
Secondary	1 .. 999

Factory pre-setting:

Primary	400
Secondary	400

Nominal voltage

The nominal voltage corresponds with the „agreed input voltage U_{din} “ according to EN 61000-4-30.

The nominal voltage specifies which value

- excess difference (EN 61000-4-30),
- low difference (EN 61000-4-30),
- transients,
- events and the
- automatic scaling of graphics

relate to.

Setting range: 0 .. 1000000V

Factory pre-setting: 230V

Transformer MAIN		
	primary	secondary
Current Transt.	5A	5A
Voltage Transt.	400V	400V
Rated Current	5A	
Rated Voltage	230V	
Apply to AUX	No	
Connection	4w3m	
esc ▾ ▲ enter		

Transformer MAIN		
	primary	secondary
Current Transt.	5A	5A
Voltage Transt.	400V	400V
Rated Current	5A	
Rated Voltage	230V	
Apply to AUX	No	
Connection	4w3m	
esc ▾ ▲ enter		

Accepting AUX / MAIN

The measuring transducer can be configured for main and auxiliary measurement. You can accept the measuring transducer settings in each case from the auxiliary or main measurement.

- **No** - The settings from the auxiliary and main measurement will not be accepted
- **Yes** - The settings from the auxiliary and main measurement will be accepted.

Transformer MAIN		
	primary	secondary
Current Transf.	5A	5A
Voltage Transf.	400V	400V
Rated Current	5A	
Rated Voltage	230V	
Apply to AUX	No	
Connection	4w3m	
esc ▾ ▲ enter		

Connection

For the voltage and current measurement, you can select between different connection diagrams. (see page 20).

Factory pre-setting: 4w3m

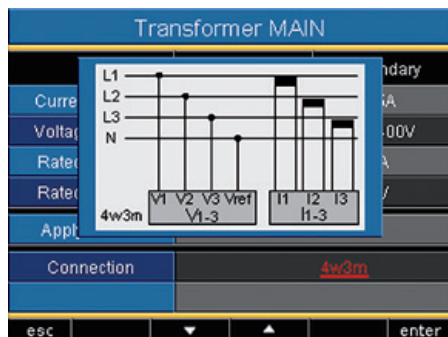

Fig. measurement in a three-phase 4 conductor network with asymmetrical load.

Transients

Transient voltages are rapid, impulsive transient oscillation processes in electrical networks. Transient voltages are not predictable with respect to time and last for a limited period.

Transient voltages are caused by the effects of lighting, due to switching operations or the triggering of fuses.

- The UMG511 recognizes transients that are longer than 50 μ s.
- The UMG511 monitors the voltage measurement inputs on transients.
- There are two independent criteria for recognizing transients.
- If a transient has been recognized, the wave shape is saved in a transient recording.
- If a transient has been recognized, the limit value is automatically increased by 20V, both in automatic and manual modes. This automatic increase of the limit value fades within 10 minutes.
- If another transient is recognized within the next 60 seconds, this transient is recorded with 512 points.
- You can display recorded transients with the GridVis incident browser.

Measurement	
Transformer	->
Transients	->
Events	->
Voltage mode	L-N
Rated Freq.	50 Hz (fixed frequency)
Flicker	230V/50Hz
esc ▼ ▲ enter	

Mode (absolute)

If a scanning value exceeds the set limit value, a transient is recognized.

- **Off** - Transient monitoring is switched off
- **Automatic** - Factory pre-setting. The limit value is automatically calculated and is 110% of the current 200 ms effective value.
- **Manual** - Transient monitoring uses the adjustable limit value under „Peak“.

Mode (delta)

If the difference of two neighbouring scanning points exceeds the set limit value, a transient is recognized.

- **Off** - Transient monitoring is switched off.
- **Automatic** - Factoring pre-setting. The limit value is calculated automatically and is 0.2175 times the current 200ms effective value.
- **Manual** - Transient monitoring uses the adjustable limit value under „Trns U“.

Mode (envelop)

If a scanning value exceeds the range of the envelope, a transient is recognized.

- **Off** - Transient monitoring is switched off.
- **Automatic** - Factoring pre-setting. The envelope is calculated automatically and is $\pm 5\%$ of nominal voltage.
- **Manual** - Transient monitoring uses the adjustable envelop.

Apply AUX / MAIN

The transient monitoring is set for the main and auxiliary measurement. You can apply the settings from the auxiliary or main measurement.

- **No** - The main and auxiliary measurement settings are not transferred.
- **Yes** - The settings of the auxiliary or main measurement will be taken.

Allocations MAIN	
Transients	
Mode (abs)	automatically
Peak U	0% (0.0V)
Mode (delta)	automatically
Trns U	0% (0.0V)
Modus (abs I)	automatically
Peak I	0% (0.0A)
Modus (envelop)	automatically
Envelop U	0% (0.0V)
Apply to AUX	No
esc	▼ ▲ No enter

Events

Events are threshold value violations of set threshold values for current and voltage.

Here, threshold values are compared with the half wave effective values for current and voltage from the measurement channels. The event record consists of a mean value, a minimum or maximum value, a start time and an end time.

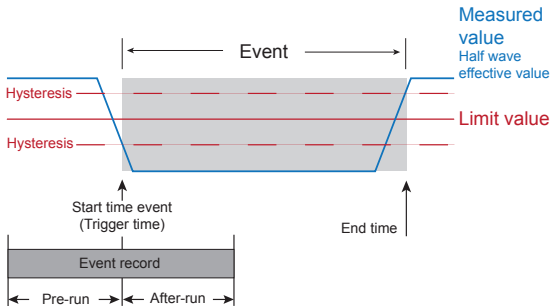

- Monitoring of the threshold values can be switched off (Off/Manual).
- Threshold values and hysteresis must be set as a percentage of the nominal value.
- Threshold values can be set for excess voltage, undervoltage, voltage interruption and overcurrent.
- If an event has occurred, the corresponding measurement value is recorded with the set pre-run and after-run periods (respectively 0..1000 half waves).
- Event records are configured with the GridVis and displayed with the event browser.

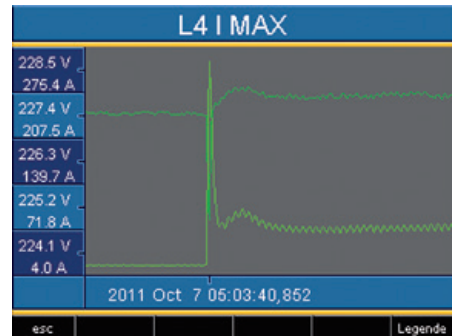

Fig. Shows the half wave effective values for an event.

Voltage

Drop

A drop in voltage is set in % of the nominal voltage.

Overvoltage

The overvoltage is set in % of the nominal voltage

Current

Overcurrent

The rapid increase of current is set in % of the nominal current.

Accept AUX / MAIN

The event monitoring is set for the main and auxiliary measurement. You can apply the settings from the auxiliary or main measurement.

- **No** - The main and auxiliary measurement settings are not transferred.
- **Yes** - The settings of the auxiliary or main measurement will be taken.

Allocations MAIN		
Voltage		
Sag	90%	(292.7V)
Swell	110%	(357.8V)
Current		
Inrush	110%	(7.8A)
Apply to AUX	No	
esc ▾ ▲ enter		



Lead time

The lead time can only be set with GridVis.

Factory pre-setting: 0



Follow-up time

The follow-up time can only be set with GridVis.

Factory pre-setting: 0

Voltage mode

Depending on the application, the voltage between the external cables (L) or the voltage between the external cables (L) and neutral wire (N) is relevant for analysis of the network quality.

The setting „L-N“ is recommended for measurement of the network quality in low voltage networks.

You should select the setting „L-L“ in medium voltage networks.

Measurement	
Transformer	->
Transients	->
Events	->
Voltage mode	L-N
Rated Freq.	50 Hz (fixed frequency)
Flicker	230V/50Hz
esc ▼ ▲ enter	



Flicker values can only be determined if the relevant voltage L-N is given.

Nominal frequency

The UMG511 determines the mains frequency from the voltage applied to L1 and uses this for the additional calculations.

The rated frequency is required as a reference for measurement of the voltage quality.

Configure the rated frequency for the mains on the UMG511 prior to starting measurement.

Select mains frequency 50Hz or 60Hz for measuring the power quality in accordance with EN61000-4-30 and EN50160.

Setting range of nominal frequency:

- 50Hz (factory pre-setting)
- 60Hz
- 15Hz .. 440Hz (wide range)

For measurements in networks with other network frequencies e.g. 16 2/3Hz or 400Hz, the nominal frequency must be set to “wide range”.

Measurement	
Transformer	->
Transients	->
Events	->
Voltage mode	L-N
Rated Freq.	50 Hz (fixed frequency)
Flicker	230V/50Hz
esc ▼ ▲ enter	



In order to determine the mains frequency, a voltage of greater than 10V_{eff} must be applied to voltage measurement input V1.

Flicker

The UMG511 requires the mains base values in order to provide voltage and frequency-independent measurement and calculation of the flicker values (flicker measurement according to DIN EN61000-4-15:2011). These values are to be specified by the user and can be selected from a predefined list:

- 230V/50Hz (factory pre-setting)
- 120V/50Hz
- 230V/60Hz
- 120V/60Hz

Measurement	
Transformer	->
Transients	->
Events	->
Voltage mode	L-N
Rated Freq.	50 Hz (fixed frequency)
Flicker	230V/50Hz
esc ▼ ▲ enter	



The flicker values can only be determined if the relevant voltage L-N is given.

System

Display of system settings specific to the device.

System	
Version	2.052
Serial	51104018
MAC	00:0E:6B:03:22:8C
Address	192.168. 3. 177
Gateway	192.168. 3. 4
Date/Time	01.01.1970 03:07:43
Password	0
Re-initialization	->

Firmware version
 Device serial number
 Fixed device MAC address
 Set IP address
 Set Gateway address
 Date and time
 Set password
 Reset settings

esc ▼ ▲ enter



You cannot configure the date and time directly on the device. Settings for time synchronization and the date and time can only be made using GridVis.

Password

The user can block access to the configuration with a password. Changing the configuration directly on the device is then only possible after entering the password.

The password consists of a 6 digit combination of numbers.

Setting range: 1-999999 = with password
000000 = without password

A password (000000) is not programmed in the factory.

- In order to change a set password, you must know the current password..
- Note any changed password.
- Once „Password“ is highlighted (green marking) the password can be changed by means of 6 (enter) and keys 2 to 5. Pressing the 6 key once more serves to confirm the entry.
- If you do not want a password request anymore, enter „000000“ as a password.



System	
Version	2.052
Serial	51104018
MAC	00:0E:6B:03:22:8C
Address	192.168. 3.177
Gateway	192.168. 3. 4
Datum/Uhrzeit	01.01.1970 01:37:06
Password	0
Zurücksetzen	->
esc	▼
▲	enter

Forgotten password

If you have forgotten the password, you can only delete the password using the „GridVis“ software. In order to do this, connect the UMG511 with the PC using a suitable interface. Further information can be found in the GridVis assistant.

Delete power meters

You can delete all power meters in the UMG511 at the same time.

A selection of certain power meters is not possible

- Select the option „Reset energy“ (green mark) and activate the option with key 6 (enter).
- Select with key 4 „yes“.
- Confirm with key 6.
- The message „done“ appears in the line - all power meters have been deleted.

Re-initialization	
Reset energy	No
Clear min/max	No
Delivery status	No
Reset	No
esc	▼
	▲
	enter

Re-initialization	
Reset energy	Yes
Clear min/max	No
Delivery status	No
Reset	No
esc	▼
	▲
	enter

Delete min. and max. values

You can delete all minimum and maximum values in the UMG 511 simultaneously.

How to delete the individual minimum and maximum values is described in the chapter „individually deleting min. and max. values“.

- Select the option „Clear min/max“ (green mark) and activate the option with key 6 (enter).
- Select with key 4 „yes“.
- Confirm with key 6.
- The message „done“ appears in the line - all minimum and maximum values have been deleted.



Prior to commissioning potential production dependant contents of the energy counter, min/max values and records have to be deleted.

Re-initialization	
Reset energy	No
Clear min/max	No
Delivery status	No
Reset	No
esc	▼
▲	enter

Re-initialization	
Reset energy	No
Clear min/max	No
Delivery status	No
Reset	No
esc	▼
▲	enter

Delivered condition

All settings such as the configuration and recorded data are reset to the factory pre-settings or deleted. Entered release codes are not deleted.

- Select with key 4 „yes“.
- Confirm with key 6.
- The message „done“ appears in the line - the factory setting is restored.

Reset

The UMG511 restarts.

- Select with key 4 „yes“.
- Confirm with key 6.
- The device will restart within 10 seconds

Re-initialization			
Reset energy	No		
Clear min/max	No		
Delivery status	No		
Reset	No		
esc	▼	▲	enter

Re-initialization			
Reset energy	No		
Clear min/max	No		
Delivery status	No		
Reset	No		
esc	▼	▲	enter

Display

Brightness

The brightness level of the background illumination can be adjusted. The brightness level set here is used during operation of the UMG511.

Setting range: 0 .. 100%

Factory pre-setting: 70%

(0% = dark, 100% = very bright)

Standby

This refers to the time before the brightness changes to „standby brightness“.

Setting range: 60 .. 9999 seconds

Factory pre-setting: 900 seconds

Standby brightness

This refers to the brightness level changed to after the end of the standby time. The standby time is restarted by using keys 1-6.

Setting range: 0 .. 60%

Factory pre-setting: 40%

Screensaver

The screensaver prevents a screen on the LCD from „sticking“ if the screen does not change for a longer period of time.

Setting range: yes, no

Factory pre-setting: yes

Display	
Brightness	70%
Standby	900s
Brightness(standby)	40%
Screen Saver	Yes
Screen Update	fast
Rotate	No
Rotation interval	0s
esc	▼
▲	enter

Presentation

You can specify the speed at which new measurement values should appear on the measurement value displays.

Setting range: fast (200ms), slow (1s)

Factory pre-setting: fast

Rotate

The measurement value displays are automatically displayed in sequence. The configuration displays are not affected by this.

Setting range: yes, no

Factory pre-setting: no

Transition time

You can set the time between automatic transition to the next measurement value display.

Setting range: 0 .. 255 seconds

Factory pre-setting: 2 second





The service life of the background illumination extends if the brightness of the background illumination is kept lower.

Colors

Selection of colors for the presentation of current and voltage in the graphic presentations.

Main menu			
Language	English		
Communication	->		
Measurement	->		
System	->		
Display	->		
Colors	->		
Extensions	->		
esc	▼	▲	enter

- Select with key 3 or 4 the color field.
- Confirm with key 6.
- Select with key 3 or 4 the required color field.
- Confirm with key 6.

Colors			
	Voltage	Current	
L1			
L2			
L3			
L4			
esc	▼	▲	enter

Extensions

Under „Extensions“ you can subsequently release charged functions (Activation) and show the status of Jasic programs (Jasic-state).

Release

The UMG511 contains chargeable functions that can be subsequently released.

List of release functions:

- BACnet
- EMAX

You receive the release code from the manufacturer. The manufacturer needs the device serial number and the name of function to be released.

In order to release the function, you enter the 6 digit release code in the respective line.

Please note that the release code is only valid for one device.

Main menu	
Language	English
Communication	->
Measurement	->
System	->
Display	->
Colors	->
Extensions	->
esc	enter

Extensions	
Activation	->
Jasic-state	->
esc	enter

Jasic status

Up to 7 specific customer Jasic programs (1-7) and one recording can run in the UMG511.

The Jasic programs can adopt the following statuses:

- Stopped
- Running

You cannot change the status of Jasic programs on the device.

Extensions	
Activation	->
Jasic-state	->
esc	enter

Extensions	
Jasic-state	
Jasic-state 1	stopped
Jasic-state 2	stopped
Jasic-state 3	stopped
Jasic-state 4	stopped
Jasic-state 5	stopped
Jasic-state 6	stopped
Jasic-state 7	stopped
Records	running
esc	

Initialization

Applying the supply voltage

- The level of supply voltage for the UMG511 can be taken from the label.
- After applying the supply voltage, a startup screen appears on the display. Around 15 seconds later, the UMG511 changes to the first measurement value display.
- If no display appears, you must check whether the supply voltage is within the nominal voltage range.



Warning!

Supply voltages that do not correspond with the details on the type label can lead to malfunctions and damage to the device.



Warning!

The UMG511 is only suitable for measurement in networks in which overvoltages of the overvoltage category 600V CATIII occur.

Apply the measurement voltage

- Voltage measurements in networks with nominal voltages above 500VAC against earth must be connected using voltage converters.
- After connection of the measurement voltages, the measurement values displayed by the UMG511 for the voltages L-N and L-L must match those at the voltage measurement input.
- If a voltage converter factor is programmed, this must be considered in the comparison.



Prior to commissioning potential production dependant contents of the energy counter, min/max values and records have to be deleted.



Warning!

The UMG511 is not suitable for measuring DC voltages.

Frequency measurement

The UMG511 needs the network frequency to measure. The network frequency can be specified by the user or automatically determined by the device.

- For automatic ascertainment of the frequency using the UMG511, an L1-N voltage larger than 10Veff must be applied to the voltage measurement input V1.
- The network frequency must be in a range between 15Hz and 440Hz.
- If a sufficiently high measurement voltage is not applied, the UMG511 cannot record the network frequency and cannot carry out the measurement.

Rotary field direction

Check the direction of the voltage rotary field in the measurement value display of the UMG511. A „right“ rotary field usually exists.

UL1-UL2-UL3 = right rotary field
UL1-UL3-UL2 = left rotary field

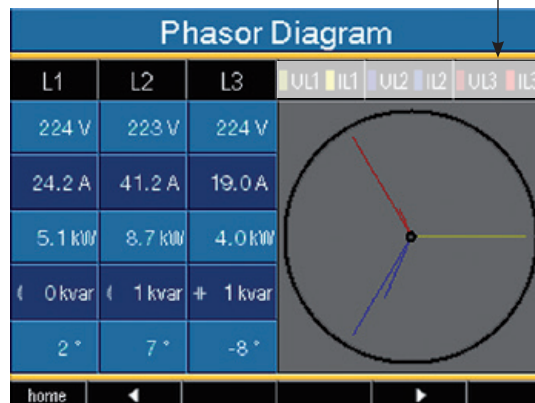

Presentation of the phase series sequence according to the rotary field direction.

Apply measurement current

The UMG511 is designed for the connection of $\dots/1A$ and $\dots/5A$ current converters.

Only AC currents, and no DC currents, can be measured using the current measurement inputs.

Short-circuit all current converter outputs apart from one. Compare the currents displayed by the UMG511 with the applied current.

Under consideration of the current converter translation ratio, the displayed current of the UMG511 must match the input current.

In short-circuited current measurement inputs, the UMG511 must display approx. zero amperes.

The current converter ratio is set to 5/5A in the factory and may be required to be adapted to the used current converter.

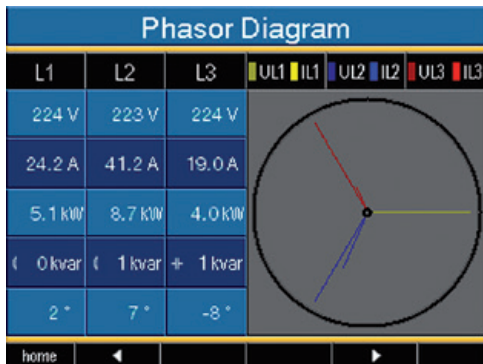

Voltages are shown with long pointers in the pointer diagram, and currents with shorter pointers.

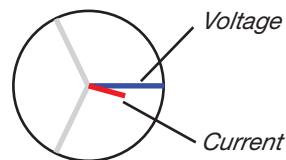

Warning!

Voltages and currents beyond the authorised measurement range can destroy the device.

Pointer diagram, example 1

Primarily ohmic load.

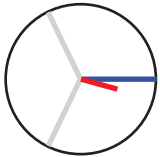

Voltage and current only have a minor difference in the phase.

- The current measurement input is allocated to the right voltage measurement input.

Pointer diagram, example 2

Primarily ohmic load.

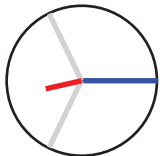

Voltage and current have a difference of approximately 180° in the phase.

- The current measurement input is allocated to the right voltage measurement input.
- In this current measurement, the connections **k and I are swapped over** or there is a return feed into the supplier network

Checking the power measurement

Short-circuit all current converter outputs except one and check the displayed power outputs.

The UMG511 may only display one power output in the phase with the current converter input that is not short-circuited. If this does not apply, please check the connection of the measurement voltage and measurement current.

If the amount of effective power is correct but the sign of effective power is negative, this may have two causes:

- Connections S1(k) and S2(l) are mixed up on the current converter.
- Effective power is returned to the network.

Checking communication

The UMG511 counts all received (RX), all sent (TX) and all faulty data packages.

In the ideal case, the number of errors shown in the error column is zero.

Reset:

You can delete the counters for the data packages with key 6.

The start time for the recount is reset.

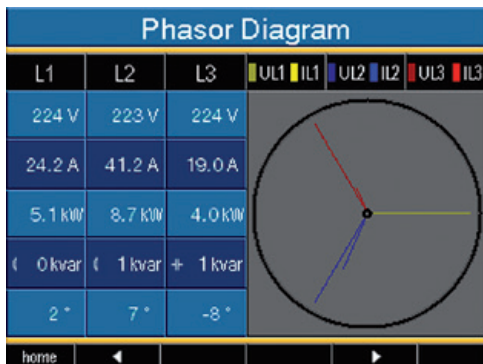

In the pointer diagram, voltages are shown with the longer pointers and currents with shorter pointers.

Communication State

	RX	TX	Error
Ethernet	625363	5728	4
RS485	0 n	0 n	0 n
NTP	0	0	0
DHCP	642	956	0
DNS	0	0	0
E-Mail	-	0	0
Start Time	10-05-2011 15:19:48		

home ◀ ▶ reset

Metering range exceedance (overload)

Metering range exceedances are displayed for as long as they are present and cannot be acknowledged. A metering range is exceeded if at least one of the four voltage or current measuring inputs is outside of its specified metering range.

Limit values for metering range exceedance:
(200 ms rms values):

$$I = 7,4 \text{ A}_{\text{rms}}$$

$$U_{\text{L-N}} = 600 \text{ V}_{\text{rms}}$$

Error - Overload		
	Voltage	Current
L1	225.5 V	0.0 A
L2	EEEE	0.0 A
L3	225.4 V	0.0 A
L4	0.5 V	EEEE

Display of the metering range exceedance in the voltage circuit L2 and in the current circuit of the 4th phase (I4).

Profibus

Profibus profile

A Profibus profile contains data to be exchanged between a UMG and an SPS. Four Profibus profiles are pre-configured in the factory

With a Profibus profile, you can:

- call-up measurement values from the UMG,
- set the digital outputs in the UMG,
- request the status of the digital inputs in the UMG.

Each Profibus profile can contain a maximum of 127Bytes. You can apply further Profibus profiles if more data has to be transferred.

- Each Profibus profile has a profile number. The profile number is sent by the PLC to the UMG.
- You can directly process 16 Profibus profiles with GridVis (profile numbers 0..15).
- Additional Profibus profiles (profile numbers 16..255) can be applied using Jasic programs.
- Factory pre-configured Profibus profiles can be subsequently changed.

Device master file

The device master file, abbreviated with GSD file, describes the Profibus characteristics of the UMG511. The GSD file is required by the PLC configuration program.

The device master file for the UMG511 has the file name „U5110C2B.GSD“ and is contained on the data carrier supplied with the delivery.

Variable definition

All system variables and global variables¹⁾ can be scaled individually and converted into one of the following formats:

- 8, 16, 32Bit integer with and without sign.
- 32 or 64Bit float format.
- Big or Little Endian.
Big-Endian = High Byte before Low Byte.
Little-Endian = Low Byte before High Byte.

¹⁾Global variables are variables that are defined by the user in Jasic and are provided to each interface in the UMG511.

Example

Collect measurement values using Profibus

You must transfer at least one Profibus profile with GridVis and transfer it to the UMG511. A Jasic program is not necessary.

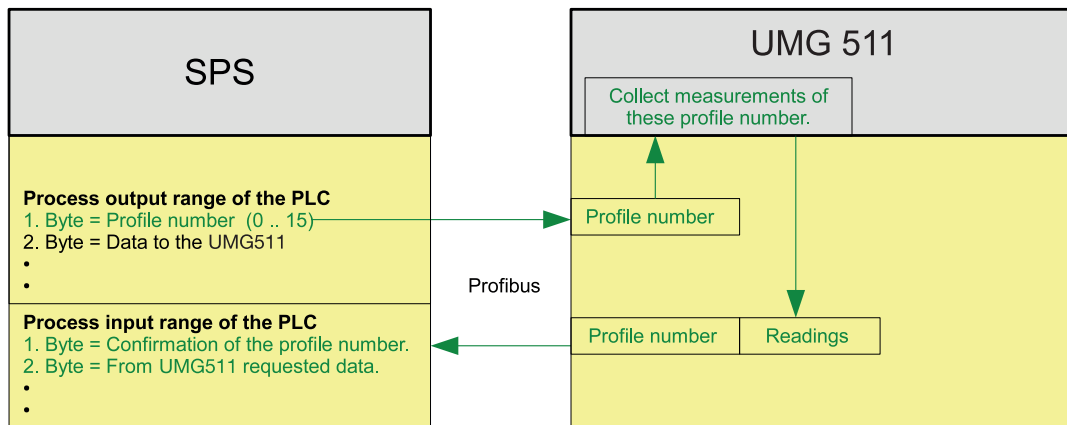

Illu. Block switch diagram for data exchange between PLC and UMG511.

Profibus profile number 0

	Byte Index	Value type	Value format	Scaling
1	1	Voltage L1-N	float	1
2	5	Voltage L2-N	float	1
3	9	Voltage L3-N	float	1
4	13	Voltage L4-N	float	1
5	17	Voltage L2-L1	float	1
6	21	Voltage L3-L2	float	1
7	25	Voltage L1-L3	float	1
8	29	Current L1	float	1
9	33	Current L2	float	1
10	37	Current L3	float	1
11	41	Current L4	float	1
12	45	Effective power L1	float	1
13	49	Effective power L2	float	1
14	53	Effective power L3	float	1
15	57	Effective power L4	float	1
16	61	Cosphi (math.) L1	float	1
17	65	Cosphi (math.) L2	float	1
18	69	Cosphi (math.) L3	float	1
19	73	Cosphi (math.) L4	float	1
20	77	Frequency	float	1
21	81	Effective power total L1-L4	float	1
22	85	Reactive power L1-L4	float	1
23	89	Apparent power total L1-L4	float	1
24	93	Cosphi (math.) total L1-L4	float	1
25	97	Effective current total L1-L4	float	1
26	101	Effective consumption total L1-L4	float	1
27	105	Ind. reactive consum. total L1-L4	float	1
28	109	THD voltage L1	float	1
29	113	THD voltage L2	float	1
30	117	THD voltage L3	float	1

Profibus profile number 1

	Byte-Index	Value type	Values-format	Scaling
1	1	Voltage L1-N	Float	1
2	5	Voltage L2-N	Float	1
3	9	Voltage L3-N	Float	1
4	13	Voltage L2-L1	Float	1
5	17	Voltage L3-L2	Float	1
6	21	Voltage L1-L3	Float	1
7	25	Current L1	Float	1
8	29	Current L2	Float	1
9	33	Current L3	Float	1
10	37	Effective power L1	Float	1
11	41	Effective power L2	Float	1
12	45	Effective power L3	Float	1
13	49	Cosphi (math.) L1	Float	1
14	53	Cosphi (math.) L2	Float	1
15	57	Cosphi (math.) L3	Float	1
16	61	Frequency	Float	1
17	65	Effective power total L1-L3	Float	1
18	69	Reactive power total L1-L3	Float	1
19	73	Apparent power total L1-L3	Float	1
20	77	Cosphi (math.) total L1-L3	Float	1
21	81	Effective current total L1-L3	Float	1
22	85	Effective consumption total L1-L3	Float	1
23	89	Ind. Reactive consum. total L1-L3	Float	1
24	93	THD voltage L1	Float	1
25	97	THD voltage L2	Float	1
26	101	THD voltage L3	Float	1
27	105	THD current L1	Float	1
28	109	THD current L2	Float	1
29	113	THD current L3	Float	1

Profibus profile number 2

	Byte-Index	Value type	Values-Format	Scaling
1	1	Effective consumption total L1-L3	Float	1
2	5	Drawn eff. consum. total L1-L3	Float	1
3	9	Supplied eff. consum. total L1-L3	Float	1
4	13	Reactive consumption total L1-L3	Float	1
5	17	Ind. reactive consum. total L1-L3	Float	1
6	21	Cap. reactive consum. total L1-L3	Float	1
7	25	Apparent consumption total L1-L3	Float	1
8	29	Effective consumption L1	Float	1
9	33	Effective consumption L2	Float	1
10	37	Effective consumption L3	Float	1
11	41	Inductive reactive consumption L1	Float	1
12	45	Inductive reactive consumption L2	Float	1
13	49	Inductive reactive consumption L3	Float	1

Profibus profile number 3

	Byte-Index	Value type	Values-Format	Scaling
1	1	Effective power L1	Float	1
2	5	Effective power L2	Float	1
3	9	Effective power L3	Float	1
4	13	Effective power total L1-L3	Float	1
5	17	Current L1	Float	1
6	21	Current L2	Float	1
7	25	Current L3	Float	1
8	29	Current total L1-L3	Float	1
9	33	Effective consumption total L1-L3	Float	1
10	37	CosPhi (math.) L1	Float	1
11	41	CosPhi (math.) L2	Float	1
12	45	CosPhi (math.) L3	Float	1
13	49	CosPhi (math.) total L1-L3	Float	1
14	53	Reactive power L1	Float	1
15	53	Reactive power L2	Float	1
16	53	Reactive power L3	Float	1
17	53	Reactive power total L1-L3	Float	1
18	53	Apparent power L1	Float	1
19	53	Apparent power L2	Float	1
20	53	Apparent power L3	Float	1
21	53	Apparent power total L1-L3	Float	1

Service and Maintenance

The device is subjected to different safety tests before delivery and marked with a seal. If a device is opened, the safety tests have to be repeated. A guarantee is only provided for unopened devices.

Repair and Calibration

Repair work and calibration can only be undertaken by the manufacturer.

Front film

Cleaning the front film can be done with a soft cloth and domestic detergent. Acids and products containing acids may not be used for cleaning.

Battery

The internal clock is fed from the supply voltage. If the supply voltage fails, the clock is supplied by the battery. The clock provides the date and time information, e.g. for recordings, minimum and maximum values and events.

The expected battery life is at least 5 years at a storage temperature of +45°C. The typical battery life is 8 to 10 years.

The device must be opened to exchange the battery. If the device has been opened, a new safety test is required for safe operation. A guarantee is only provided for unopened devices.

Disposal

The UMG511 can be recycled as electronic scrap in accordance with the legal regulations. The fixed, integrated lithium battery must be disposed of separately.

Firmware update

If a firmware update has to be carried out for your UMG511, you can do this with the GridVis software included in the delivery.

Service

Should any questions arise that are not described in this handbook please contact the manufacturer directly.

We will require the following compulsory details from you for processing:

- Device name (refer to label),
- Serial number (refer to label),
- Software release (refer to measurement value display),
- Measurement voltage and supply voltage,
- Precise error description.

Procedure in case of an error

Possible error	Cause	Help
No display.	The external fuse for the supply voltage has triggered.	Replace fuse.
No current display.	Measurement voltage is not connected.	Connect the measurement voltage.
	Measurement current is not connected.	Connect the measurement current.
The displayed current is too high or too low.	Current measurement in the wrong phase.	Check and correct the connection if necessary.
	Current converter factor is incorrectly programme	Read and program the current converter translation ratio on the current converter.
The displayed voltage is too low or too high.	Measurement in the wrong phase.	Check and correct the connection if necessary.
	The voltage converter is incorrectly programmed.	Read and program the voltage converter translation ratio on the voltage converter.
The displayed voltage is too small.	Measurement range exceeded.	Use a voltage converter.
	The voltage peak value at the measurement input has been exceeded by harmonics.	Caution! It is compulsory to check that the measurement inputs are not overloaded.
The active power is too low or too high.	The programmed current converter translation ratio is incorrect.	Read and program the current converter translation ratio on the current converter.
	The current path is allocated to the wrong voltage path.	Check and correct the connection if necessary.
	The programmed current converter translation ratio is incorrect.	Read and program the voltage converter translation ratio on the voltage converter.

Possible error	Cause	Help
Metering range exceedance (overload)	Voltage or current input out of range (see chapter metering range exceedance)	Check and correct the connection if necessary.
		Use suitable voltage or current transformers
		Read and program the current or voltage transformer ratio on the transformer.
The active power receipt/supply is mixed up.	At least one current converter connection is mixed up.	Check and correct the connection if necessary.
	A current path is allocated to the wrong voltage path.	Check and correct the connection if necessary.
No connection to the device.	RS485: <ul style="list-style-type: none"> - Device address incorrect. - Different bus speeds (Baudrate). - Incorrect protocol. - Termination is missing. 	<ul style="list-style-type: none"> - Set the device address. - Check and correct the speed (baudrate) - Select protocol. - Connect the bus with terminal resistance (120 Ohm).
	Ethernet: <ul style="list-style-type: none"> - IP address incorrect 	<ul style="list-style-type: none"> - Set the IP address on the device
The device does not work despite the above measures.	Defective device.	Send the device to the manufacturer with an exact description of the fault.

Technical data

General	
Net weight	1080g
Device dimensions	approx. l=144mm, w=144mm, h=75mm
Battery	Typ VARTA CR1/2AA, 3 V, Li-Mn

Transport and storage	
The following details are valid for devices that are transported or stored in the original packaging.	
Drop test	1m
Temperature	-20°C to +70°C

Environmental conditions in operation	
The UMG511 is intended for use in a weather-protected, fixed extradata. The UMG511 must be connected to the protective wire connection! Protection class I according to IEC 60536 (VDE 0106, part 1)	
Working temperature range	-10°C .. +55°C
Relative humidity	5 to 95 %, (at +25 °C) without condensation
Degree of pollution	2
Operating height	0 .. 2000m above sea level
Installation position	user-defined
Ventilation	external ventilation is not required.
Foreign particles and water protection	
- Front	IP50 according to EN60529
- Back	IP20 according to EN60529

Supply voltage	
Installation overvoltage category	300V CAT III
Safeguarding of supply voltage (circuit breaker)	6A Char. B (approved by UL/IEC)
Option 230V (Item-Nr. 52.19.001) - Nominal range: - Working range: - Power consumption:	95V .. 240V (45-65Hz) or DC 80V .. 340V +6% /-10% of nominal range max. 10W, max. 15VA
Option 90V (Item-Nr. 52.19.002) - Nominal range: - Working range: - Power consumption:	44V .. 130V (45-65Hz) or DC 48V .. 180V ±10% of nominal range max. 6W, max. 9VA
Option 24V (Item-Nr. 52.19.003) - Nominal range: - Working range: - Power consumption:	20V .. 50V (45-65Hz) or DC 20V .. 70V ±10% of nominal range max. 7W, max. 9VA

Connectable cables (supply voltage)	
Only one cable per clamp may be connected!	
Single wire, multi-wire, fine wire	0.2 - 2.5mm ² , AWG 24 - 12
Wire end ferrules with and without plastic sleeves	0.25 - 2.5mm ²
Torque	0.5 - 0.6Nm
Strip length	7mm

Inputs and outputs	
8 digital inputs	
- Maximum counting frequency	20Hz
- Reaction time (Jasic programme)	200ms
- Input signal is applied	18V .. 28V DC (typical 4mA)
- Input signal is not applied	0 .. 5V DC, current lower than 0.5mA
5 digital outputs, semi conductor relay, not short-circuited	
Switching voltage	max. 60V DC, 30V AC
Switching current	max. 50m A _{eff} AC/DC
Reaction time (Jasic programme)	200ms
Issue of voltage dips	20ms
Issue of voltage excesses	20ms
Impulse output (working impulse)	max. 20Hz
Cable length	
	up to 30m not shielded, larger than 30m shielded

Connection capacity of clamping points (inputs and outputs)	
Rigid/flexible	0.14 - 1.5mm ² , AWG 28-16
Flexible with wire end ferrules without plastic sleeves	0.25 - 1.5mm ²
Flexible with wire end ferrules with plastic sleeves	0.25 - 0.5mm ²
Torque	0.22 - 0.25Nm
Strip length	7mm

Voltage measurement	
The voltage measuring inputs are suitable for the following grids of power supply:	
Three-phase 4 conductor systems with nominal voltages till	417V/720V (+10%)
Three-phase 3 conductor systems with nominal voltages till	600V (+10%)
The voltage measuring inputs regarding safety and reliability reasons are dimensioned as follows:	
Overvoltage category	600V CAT III
Measurement surge voltage	6kV
Measuring range L-N	0 ¹⁾ .. 600V _{rms}
Measuring range L-L	0 ¹⁾ .. 1000V _{rms}
Resolution	0.01V
Crest factor	1,6 (relating to 600V _{rms})
Impedance	4MΩm/phase
Power consumption	ca. 0.1VA
Scanning frequency	20kHz/phase
Transients	50µs
U _{din} ²⁾ according to EN61000-4-30	100 .. 250V
Flicker range (dU/U)	27.5%
Frequency of fundamental oscillation	15Hz .. 440Hz
- Resolution	0.001Hz

- 1) The UMG511 can only ascertain measurement values when a measurement voltage higher than 10V_{eff} L-N or 18V_{eff} L-L is applied to at least one voltage measurement input
- 2) U_{din} = agreed input voltage according to DIN EN 61000-4-30

Current measurement	
Rated current	5A
Resolution	0.1mA
Measuring range	0.001 .. 7.4A _{rms}
Crest factor	2.4
Overvoltage category	300V CAT III
Measurement surge voltage	4kV
Power consumption	ca. 0.2 VA (Ri=5 mohm)
Overload for 1 second	120A (sinusoidal)
Scanning frequency	20kHz

Connectable cables (current measurement and voltage measurement)	
Only one cable per clamp may be connected!	
Single wire, multi-wire, fine wire	0.2 - 2.5mm ² , AWG 24-12
Pin cable lugs, wire end ferrules	0.25 - 2.5mm ²
Torque	0.5 - 0.6Nm
Strip length	7mm

Function parameters

- Measurement using current converters ../5A
- Measurements at 50/60 Hz

Function	Symbol	Accuracy class	Measur. range	Display range
Total effective power	P	0.2 ⁵⁾ (IEC61557-12)	0 .. 15.3kW	0 W .. 9999 GW *
Total reactive power	QA ⁶⁾ , Qv ⁶⁾	1 (IEC61557-12)	0 .. 15.3 kvar	0 varh .. 9999 Gvarh *
Total apparent power	SA, Sv ⁶⁾	0.2 ⁵⁾ (IEC61557-12)	0 .. 15.3 kVA	0 VA .. 9999 GVA *
Total effective energy	Ea	0.2 ⁵⁾ (IEC61557-12)	0 .. 15.3 kWh	0 Wh .. 9999 GWh *
Total reactive energy	ErA ⁶⁾ , ErV ⁶⁾	1 (IEC61557-12)	0 .. 15.3 kvarh	0 varh .. 9999 Gvarh *
Total apparent energy	EapA, EapV ⁶⁾	0.2 ⁵⁾ (IEC61557-12)	0 .. 15.3 kVAh	0 VAh .. 9999 GVAh *
Frequency	f	0.05 (IEC61557-12)	40 .. 70 Hz	40 Hz .. 70 Hz
Phase current	I	0.2 (IEC61557-12)	0.001 .. 7.4 Arms	0 A .. 9999 kA
Neutral cond. current measured	IN	0.2 (IEC61557-12)	0.001 .. 7.4 Arms	0 A .. 9999 kA
Neutral cond. current calculated	INc	0.5 (IEC61557-12)	0.001 .. 22.2 A	0 A .. 9999 kA
Voltage	U L-N	0.1 (IEC61557-12)	10 .. 600 Vrms	0 V .. 9999 kV
Voltage	U L-L	0.1 (IEC61557-12)	18 .. 1000 Vrms	0 V .. 9999 kV
Power factor	PFA, PFV	0.5 (IEC61557-12)	0.00 .. 1.00	0 .. 1
Short-time flicker, long-time fl.	Pst, Plt	KI. A (IEC61000-4-15)	0.4 Pst to 10.0 Pst	0 .. 10
Voltage drops	Udip	0.2 (IEC61557-12)	10 .. 600 Vrms	0 V .. 9999 kV
Voltage rises	Uswl	0.2 (IEC61557-12)	10 .. 600 Vrms	0 V .. 9999 kV
Transient overvoltages	Utr	0.2 (IEC61557-12)	10 .. 600 Vrms	0 V .. 9999 kV
Voltage interruptions	Uint	Duration + - 1 cycle	-	-
Voltage inbalance ¹⁾	Unba	0.2 (IEC61557-12)	10 .. 600 Vrms	0 V .. 9999 kV
Voltage inbalance ²⁾	Unb	0.2 (IEC61557-12)	10 .. 600 Vrms	0 V .. 9999 kV
Voltage harmonics	Uh	Cl. 1 (IEC61000-4-7)	to 2.5 kHz	0 V .. 9999 kV
THD of voltage ³⁾	THDu	1.0 (IEC61557-12)	to 2.5 kHz	0 % .. 999 %

THD of voltage ⁴⁾	THD-Ru	1.0 (IEC61557-12)	to 2.5 kHz	0 % .. 999 %
Current harmonics	Ih	KI. 1 (IEC61000-4-7)	to 2.5 kHz	0 A .. 9999 kA
THD of current ⁵⁾	THDi	1.0 (IEC61557-12)	to 2.5 kHz	0 % .. 999 %
THD of current ⁴⁾	THD-Ri	1.0 (IEC61557-12)	to 2.5 kHz	0 % .. 999 %
Mains signal voltage (voltage inter-harmonics)	MSV	IEC 61000-4-7 Class 1	10% – 200% of IEC 61000-2-4 Class 3	0 V .. 9999 kV

- Measurements at 15 Hz ...440 Hz

Function	Symbol	Accuracy class	Measurem. range	Display range
Total effective power	P	2 (IEC61557-12)	0 .. 15.3kW	0 W .. 9999 GW *
Total reactive power	QA ⁶⁾ , Qv ⁶⁾	2 (IEC61557-12)	0 .. 15.3 kvar	0 varh .. 9999 Gvar *
Total apparent power	SA, Sv ⁶⁾	1 (IEC61557-12)	0 .. 15.3 kVA	0 VA .. 9999 GVA *
Total effective energy	Ea	2 (IEC61557-12)	0 .. 15.3 kWh	0 Wh .. 9999 GWh *
Total reactive energy	ErA ⁶⁾ , ErV ⁶⁾	2 (IEC61557-12)	0 .. 15.3 kvarh	0 varh .. 9999 Gvarh *
Total apparent energy	EapA, EapV ⁶⁾	1 (IEC61557-12)	0 .. 15.3 kVAh	0 VAh .. 9999 GVAh *
Frequency	f	0.05 (IEC61557-12)	15 .. 440 Hz	15 Hz .. 440 Hz
Phase current	I	0.5 (IEC61557-12)	0.001 .. 7.4 Arms	0 A .. 9999 kA
Neutral cond. current measured	IN	0.5 (IEC61557-12)	0.001 .. 7.4 Arms	0 A .. 9999 kA
Neutral cond. current calculated	INc	1.5 (IEC61557-12)	0.001 .. 22.2 A	0 A .. 9999 kA
Voltage	U L-N	0.5 (IEC61557-12)	10 .. 600 Vrms	0 V .. 9999 kV
Voltage	U L-L	0.5 (IEC61557-12)	18 .. 1000 Vrms	0 V .. 9999 kV

Function	Symbol	Accuracy class	Measur. range	Display range
Power factor	PFA, PFV	2 (IEC61557-12)	0.00 .. 1.00	0 .. 1
Short-time flicker, long-time fl.	Pst, Plt	-	-	-
Voltage drops	Udip	0.5 (IEC61557-12)	10 .. 600 V _{rms}	0 V .. 9999 kV
Voltage rises	Uswl	0.5 (IEC61557-12)	10 .. 600 V _{rms}	0 V .. 9999 kV
Transient overvoltages	Utr	0.5 (IEC61557-12)	10 .. 600 V _{rms}	0 V .. 9999 kV
Voltage interruptions	Uint	Duration + - 1 cycle	-	-
Voltage imbalance ¹⁾	Unba	0.5 (IEC61557-12)	10 .. 600 V _{rms}	0 V .. 9999 kV
Voltage imbalance ²⁾	Unb	0.5 (IEC61557-12)	10 .. 600 V _{rms}	0 V .. 9999 kV
Voltage harmonics	Uh	Cl. 2 (IEC61000-4-7)	to 2,5 kHz	0 V .. 9999 kV
THD of voltage ³⁾	THDu	2.0 (IEC61557-12)	to 2,5 kHz	0 % .. 999 %

Explanations

- 1) Reference to amplitude.
- 2) Reference to phase and amplitude.
- 3) Reference to basic oscillation
- 4) Reference to effective value.
- 5) Accuracy class 0.2 with ../5A converter.
Accuracy class 0.5 with ../1A converter.
- * The display returns to 0 W once the max. total working value range has been reached.
- 6) Calculation from fundamental harmonic oscillation.

UMG511 Specifications for IEC 61000-4-30 Compliance

Parameter	Uncertainty	Measuring Range
5.1 Frequency	± 10 mHz	42.5 Hz – 57.5 Hz, 51Hz – 69 Hz
5.2 Magnitude of Supply Voltage	$\pm 0.1\%$ of U_{din}	10% – 150% of U_{din}
5.3 Flicker	$\pm 5\%$ of reading	0.2 – 10 Pst
5.4 Supply Voltage Dips and Swells	Magnitude: $\pm 0.2\%$ of U_{din} Duration: ± 1 cycle	N/A
5.5 Voltage Interruptions	Duration: ± 1 cycle	N/A
5.7 Unbalance	$\pm 0.15\%$	0.5% – 5% u_2 0.5% – 5% u_0
5.8 Harmonics	IEC 61000-4-7 Class 1	10% – 200% of Class 3 of IEC 61000-2-4
5.9 Interharmonics	IEC 61000-4-7 Class 1	10% – 200% of Class 3 of IEC 61000-2-4
5.10 Mains Signaling Voltage	3% – 15% of U_{din} , $\pm 5\%$ of measured 1% – 3% of U_{din} , $\pm 0.15\%$ of U_{din} <1% of U_{din} , no requirement	0% – 15% of U_{din}
5.12 Underdeviation and Overdeviation	$\pm 0.1\%$ of U_{din}	10% – 150% of U_{din}

The UMG511 meets IEC 61000-4-30 Class A requirements for:

- Aggregations, Time Clock Uncertainty, Flagging, Transient Influence Quantities



In order to ensure that two measurement devices achieve the same measurement results in a 10 minute compensation interval, we recommend synchronising time measurements in the UMG511 using an external time signal.

Serial interfaces

RS485	
Terminal	plug, SUB D 9-pin
Protocol, Modbus RTU - Transfer rate	Modbus RTU/Slave, Modbus RTU/Master - 9.6kbps, 19.2kbps, 38.4kbps, 57.6kbps, 115.2kbps, 921,6kbps
Protocol, Profibus (Option) - Transfer rate	Profibus DP/V0 according to EN 50170 - 9.6kBaude to 12MBAude
Protocol, BACnet (Option)	

Ethernet 10/100Base-TX (Option)	
Terminal	RJ-45
Functions	Modbus Gateway, Embedded Webserver (HTTP)
Protocols	CP/IP, EMAIL (SMTP), DHCP-Client (BootP), Modbus/TCP, Modbus RTU over Ethernet, FTP, ICMP (Ping), NTP, TFTP, BACnet (Option), SNMP, BACnet (Option)

Declaration of Conformity

The product fulfils the following EC Directives:	
2004/108/EG	Electromagnetic compatibility of electrical equipment.
2006/95/EG	Electrical equipment for use within certain voltage limits.
Considered standards:	
Noise immunity IEC/EN 61326-1:2013 IEC/EN 61000-4-2:2009 IEC/EN 61000-4-3:2011 IEC/EN 61000-4-3:2011, EMV-ILA V01-03 IEC/EN 61000-4-4:2013, EMV-ILA V01-03 IEC/EN 61000-4-5:2007, EMV-ILA V01-03 IEC/EN 61000-4-6:2009, EMV-ILA V01-03 IEC/EN 61000-4-8:2010 IEC/EN 61000-4-11:2005, EMV-ILA V01-03	Class A: Industrial environment Electrostatic discharge Electromagnetic RF Field 80-1000MHz Electromagnetic RF Field 1000-2700MHz Burst Surge Conducted disturbances 0.15-80MHz Power frequency magnetic field Voltage dips, short interrupts, voltage variations and frequency changes
Noise emission IEC/EN 61326-1:2013 IEC/CISPR11/EN 55011:2011 IEC/CISPR11/EN 55011:2011 EMV-ILA V01-03 EMV-ILA V01-03	Class B: Residential environment Radio disturbance field strength 30-1000MHz Radio disturbance voltage 0.15-30MHz Radio disturbance voltage 9-150kHz Flicker
Equipment safety IEC/EN 61010-1:2011 IEC/EN 61010-2-030:2011	Safety requirements for electrical equipment for Measurement, control and laboratory use – Part 1: General requirements Particular requirements for testing and measuring circuits

Dimensional drawings

Cut out size: $138^{+0,8} \times 138^{+0,8}$ mm

Back

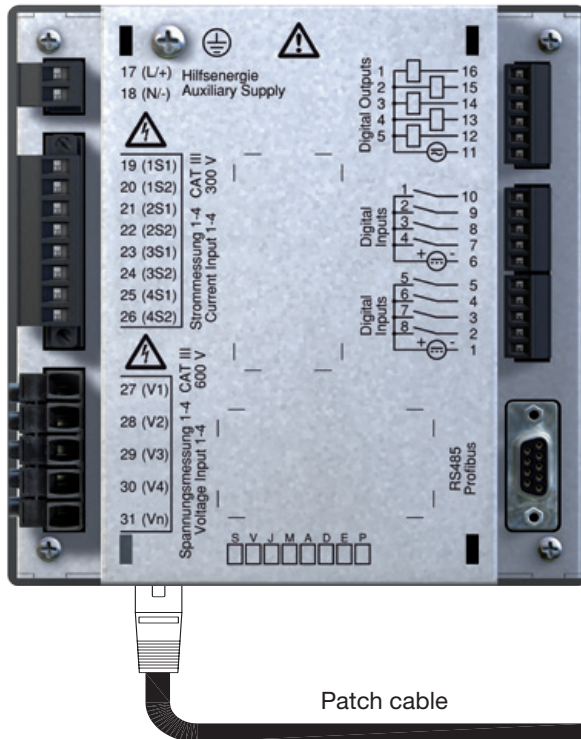

Patch cable

Side view

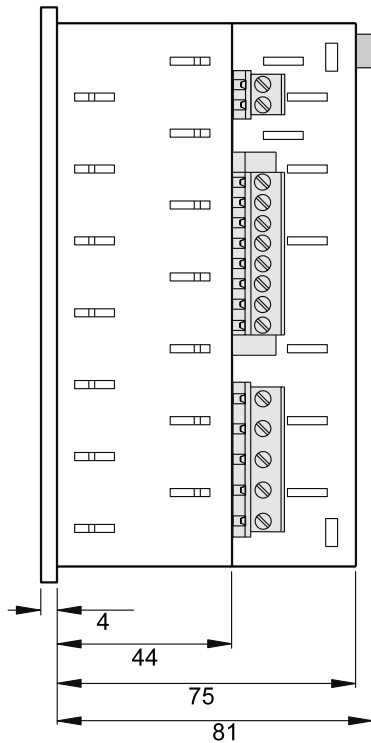

View from below

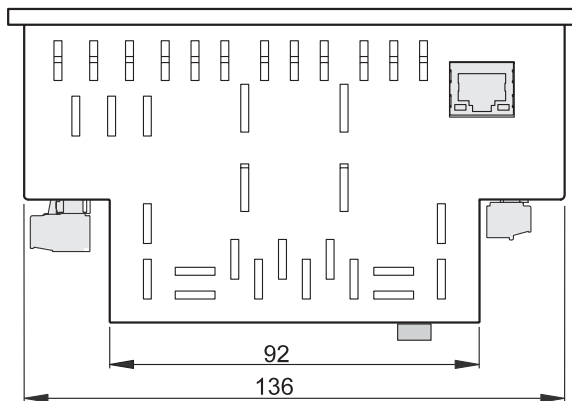

Configuration overview

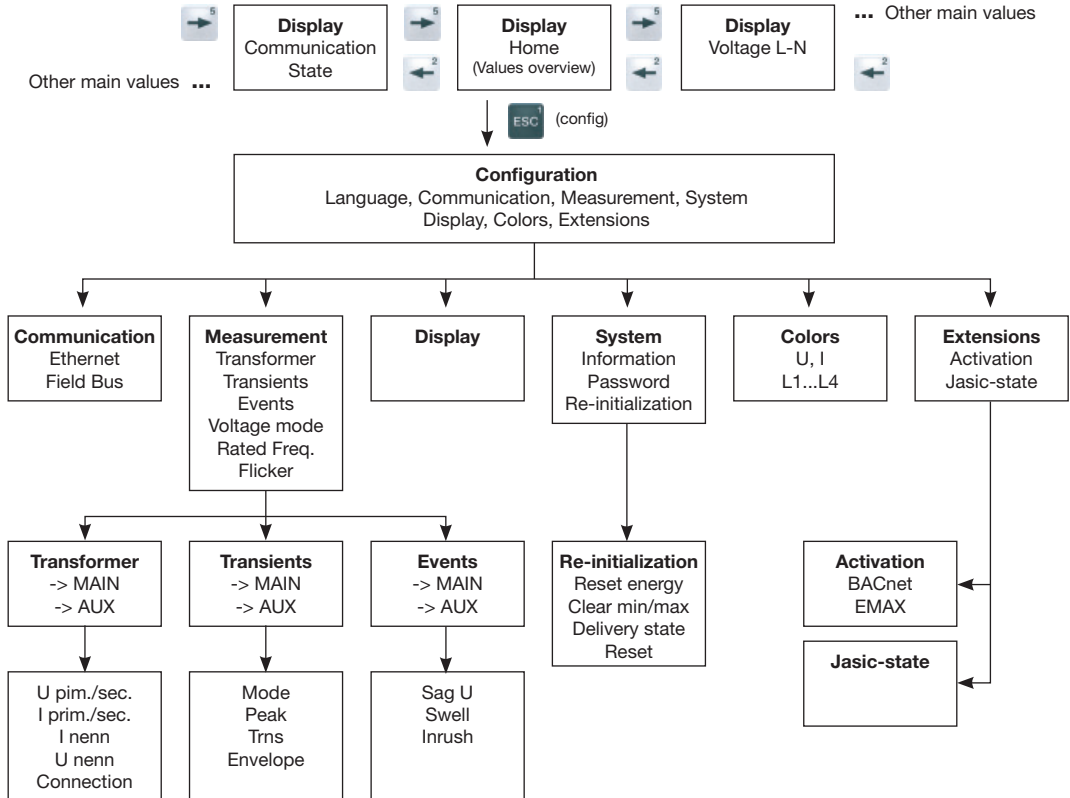

Measurement value displays overview (1)

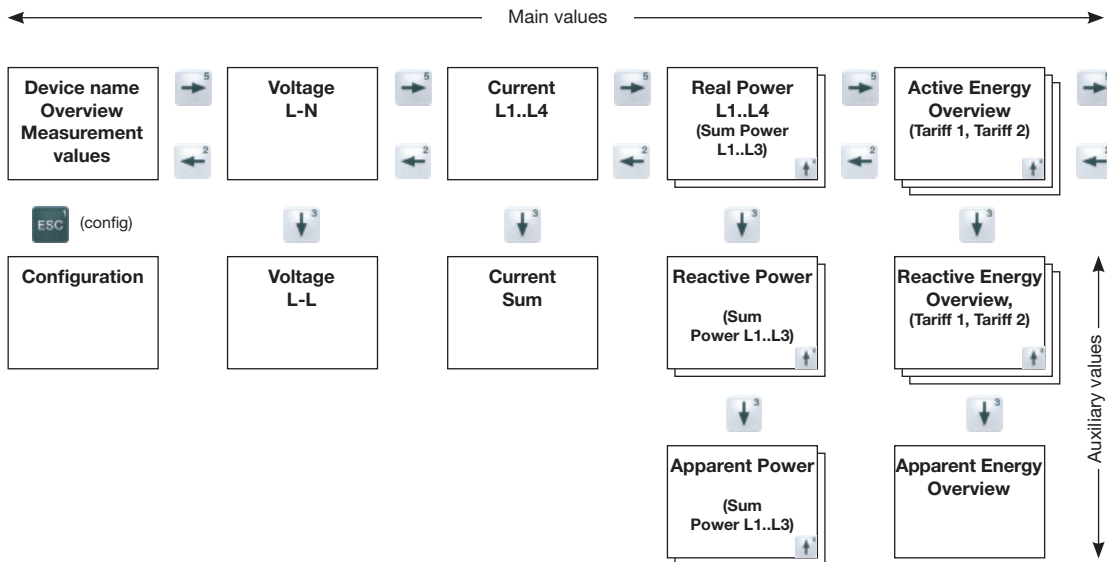

Measurement value displays overview (2)

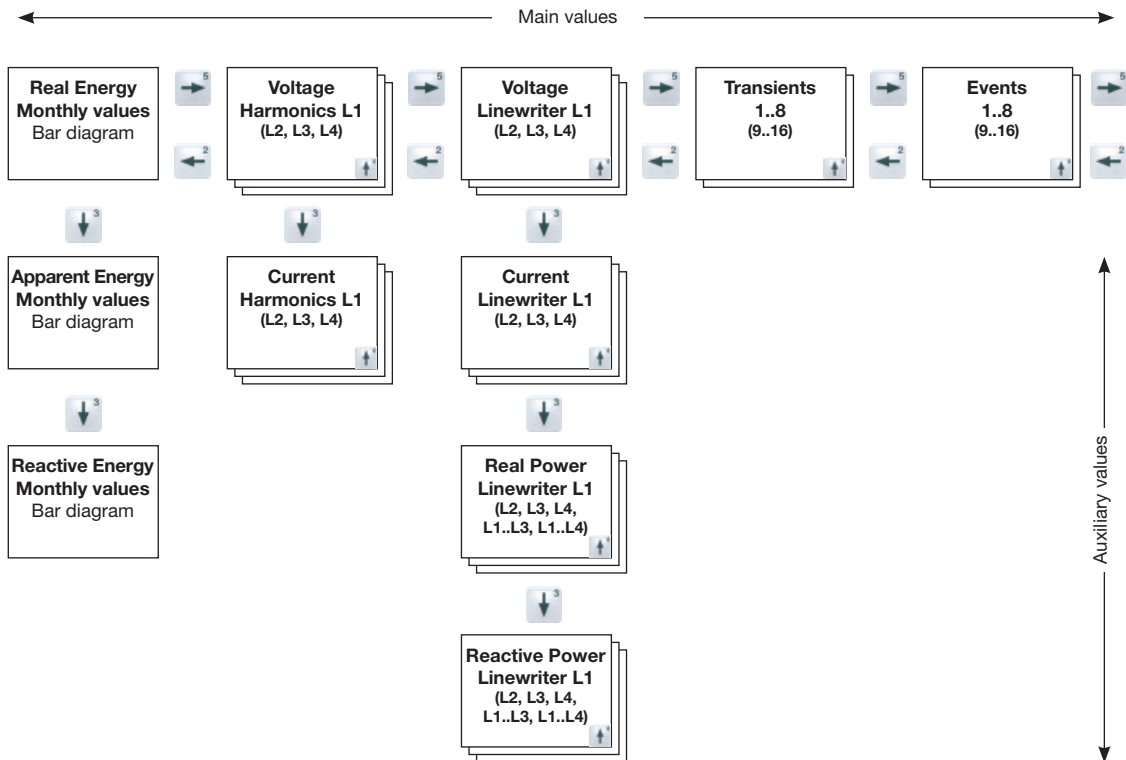

Measurement value displays overview (3)

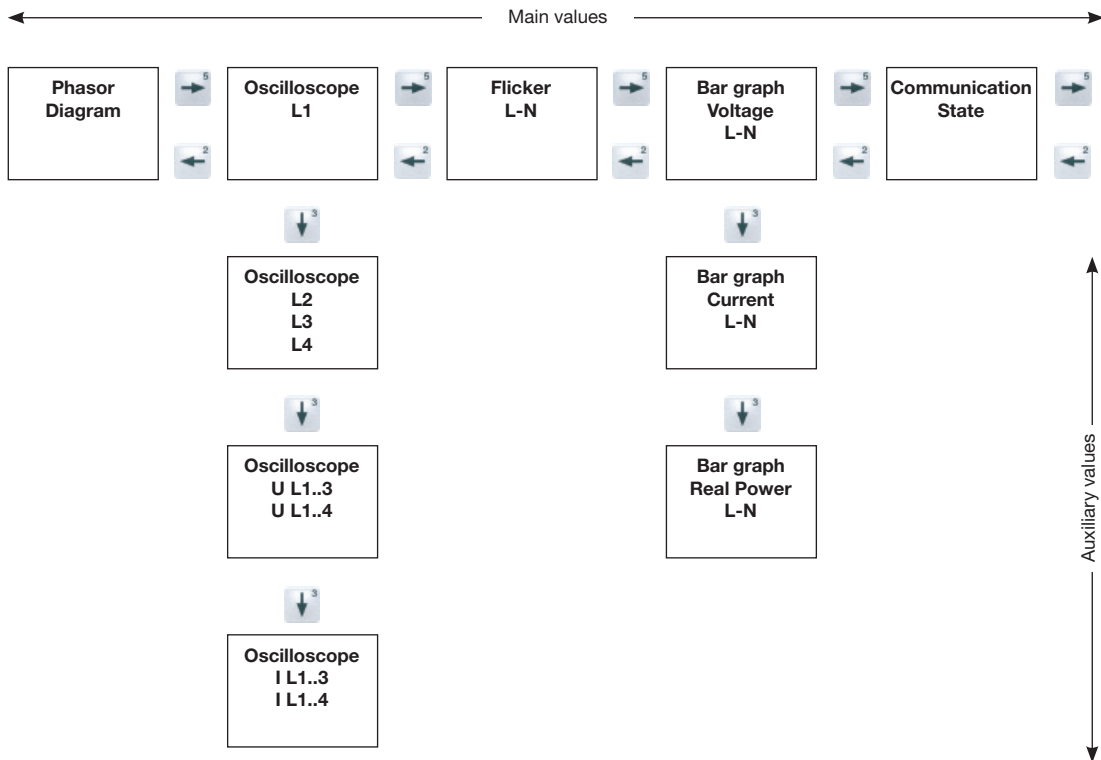

Connection example for UMG511

